

APA-4E8, APA-4E6

ADAPTIVE PROCESSING AMPLIFIER

Operator's Manual Revision 1.03

XTA Electronics Ltd.
Vale Business Park,
Worcester Road,
Stourport-on-Severn,
Worcestershire
DY13 9BZ
England

Tel: +44(0)1299 879977
Fax: +44(0)1299 879969
www.xta.co.uk



© XTA Electronics Ltd 2019

Revision 04.19
For comments, suggestions, errors or omissions, please
contact XTA at the address above, or email info@xta.co.uk

CONTENTS

INTRODUCING YOUR APA: 7

IMPORTANT SAFETY INSTRUCTIONS 8

INSTRUCTIONS DE SECURITE IMPORTANTES 9

DECLARATION OF CONFORMITY 10

INSTALLING YOUR APA: 11

 Unpacking 11

 Additional Symbols and Warnings 11

 Electrical Considerations 12

 Mechanical Considerations 13

CONNECTING TO YOUR APA: 14

 Audio Inputs Wiring 14

 RS485 Output Wiring 14

 Speaker Outputs Wiring 15

GETTING TO KNOW YOUR APA: 16

 Front Panel Layout and Controls 16

 Rear Panel Controls and Sockets 18

 Rear Panel Status LED Groups 19

 GPIO Connections 19

 Signal Paths and Block Diagram 20

 Input Sources 22

 AES Inputs 22

 Pre-Matrix Processing 23

 Processed Input Channel Blocks 24

 Mix Matrix to Power Amp Processing Channels / Network Outputs 25

 Power Amp Channels Processing Blocks 26



OPERATING YOUR APA:	28
Powering Up	28
Powering Down and Returning Home	29
Home Screen Layout	30
The "Monochrome Concept"	30
User Metrics	31
Incoming Mains Monitor	31
Amplifier Temperatures	32
Quick Inputs Monitor	33
Amp Channel Loads	34
Auto Scrolling of User Metrics	35
Tri Colour Panel Metering	36
Output Channel Menu	37
Overview	37
Quick Gain Trim	37
Output Preset	38
Limiter Threshold	38
Output Polarity (Phase Reverse)	38
System Menu	39
Overview	39
UNDERSTANDING YOUR APA	40
Memories, Presets and File Structures	40
Internal SD Card	40
USB Flash Drives: Firmware Upgrades and Presets/Memories	40
The Concept of File Syncing	42
Recalling Unit Memories	43
Upgrading Firmware via Ethernet	45
Upgrading Firmware via USB	51
Mains RMS Current Limiter	54
Identify Unit	55
Default Audio	55
Default User Settings	56
Emergency Voice Evacuation Playback	57
System Security	58
Overview and Locking Procedure	58
Forgotten Your Password?	58
System Warnings	59

REMOTE CONNECTION TO YOUR APA	61
Overview	61
Connect to a Network	61
Adhoc Connections (no DHCP Server)	62
Manual (fixed) IP Address Selection	62
AudioCore ID Number	63
LOOKING AFTER YOUR APA:	64
Maintenance	64
Warranty	64
PERFORMANCE OF YOUR APA:	65
Technical Specifications	65
General	65
Audio System	65
Digital Audio	66
Storage & Losses	66
Physical and Mechanical	66
Input Power	67
Output Power: Peak Performance	67
Output Power: Continuous Performance	68
Power Measurement Test Types	69
Test type 1: Continuous RMS Sine Wave	69
Test type 2: Continuous Pink Noise	69
Test type 3: Short Burst Sine Wave	69
Test type 4: Long Burst Sine Wave	69



ADDITIONAL INFORMATION ABOUT YOUR APA:.....	70
Appendix I: Dynamic EQ	70
Mode I: "Cut Above"	70
Mode II: "Cut Below"	71
Mode III: "Boost Above"	72
Mode IV: "Boost Below"	73
Appendix II: Program Limiter and Peak Limiter	74
Program Limiter	74
Peak Limiter	75
Setting Accurate Limiter Thresholds – Program Limiter	78
Setting Accurate Limiter Thresholds – Peak Limiter	79
Setting Appropriate Attack and Release Times	79
Appendix III: Parametric Filter Types and Uses	80
Standard Parametric EQ	80
High/Low Shelving EQ	82
Creating a Flat-topped EQ Response	83
Bandpass Filter	84
Notch Filter	85
All Pass Filter	86
Phase Filter	87
Low/High Pass Variable 'Q' Filter	88

Introducing Your APA:

Thank you for choosing an APA Series adaptive processing amplifier for your application. Please spend a little time reading through this manual, so that you obtain the best possible performance from the unit and become familiar with its operating requirements.

All XTA products are carefully designed and engineered for cutting-edge performance and world-class reliability. If you would like further information about this or any other XTA product, please contact us.

We wish you many years of flawless service from this unit and look forward to hearing from you in the near future.

The APA Series – Adaptive Processing Amplification – are four channel Class D amplifiers with extensive processing, connectivity and control capabilities. The new power and DSP platforms have been designed to interact intelligently and adapt to prevailing conditions, protecting drivers, and significantly enhancing performance from all speaker systems.

The power stages and processing tightly integrate with the power supply featuring 96k analogue to digital converters not only on the analogue inputs but also directly at the speaker outputs, monitoring voltage and current. Inputs and outputs are simultaneously being processed by the DSP, along with data about the mains supply, allowing the APA to adapt and correct to keep your music sounding better than ever.

The energy storage capabilities of the amplifier are such that it can also maintain peak power output for periods that are musically useful and not just good on paper. The high efficiency of the output stages and power supply also mean that heat production is reduced, resulting in sustained long term power delivery, even in to very low impedance or difficult loads.

In addition to this adaptive processing, you still have full control over a powerful suite of filtering and protection, including multiple bands of our legendary dynamic EQ, FIR filtering and phase linearisation, ultra-transparent compression and limiting, plus all the classic crossover and EQ components traditionally used to set up your system.

Add to this a fully flexible matrix with the ability to source audio either locally from AES or analogue inputs, or via a networked audio connection (Dante/AVB). With Ether net based PC remote software control also part of the package, you'll understand why we don't think this is just an amplifier with some DSP built in...



Important Safety Instructions



**CAUTION: RISK OF ELECTRIC SHOCK.
DO NOT OPEN**



The lightning flash with arrowhead symbol within an equilateral triangle is intended to alert the user to the presence of uninsulated "dangerous voltage" within the product's enclosure that may be of sufficient magnitude to constitute a risk of electric shock to persons.



The exclamation mark within an equilateral triangle is intended to alert the user of important operating and maintenance (servicing) instructions in the literature accompanying the appliance.

WARNING: Apparatus with CLASS I construction shall be connected to a MAINS socket outlet with a protective earthing connection.

WARNING: To prevent injury, this apparatus must be securely attached to the rack in accordance with the installation instructions.

1. Read these instructions.
2. Keep these instructions.
3. Heed all warnings.
4. Follow all instructions.
5. Do not use this apparatus near water.
6. Clean only with a dry cloth.
7. Do not block any ventilation openings, install in accordance with the manufacturer's instructions.
8. Do not install near any heat sources, such as radiators, heat registers, stoves or other apparatus (including amplifiers) that produce heat.
9. Do not defeat the safety purpose of the polarized or grounding-type plug. A polarized plug has two blades with one wider than the other. A grounding-type plug has two blades and a third grounding prong. The wide blade or the third prong are provided for your safety. If the provided plug does not fit into your outlet, consult an electrician for replacement of the obsolete outlet.
10. Protect the power cord from being walked on or pinched particularly at plugs, convenience receptacles and the point where they exit from the apparatus.
11. Only use attachments/accessories specified by the manufacturer.



12. Use only with the cart, tripod, bracket or table specified by the manufacturer, or sold with the apparatus. When a cart is used, use caution when moving the cart/apparatus combination to avoid injury from a tip over.

13. Unplug this apparatus during lightning storms or when unused for a long period of time.

14. Refer all servicing to qualified service personnel. Servicing is required when the apparatus has been damaged in any way, such as if the power-supply cord or plug is damaged, liquid has been spilled or objects have fallen into the apparatus, the apparatus has been exposed to rain or moisture, does not operate normally, or has been dropped.

15. Do not expose this equipment to dripping or splashing and ensure that no objects filled with liquids, such as vases, are placed on the equipment.

16. To completely disconnect this equipment from the AC mains, disconnect the power cord from the mains circuit breaker.

17. This unit is fitted with a 3-wire power cord. For safety reasons, THE EARTH LEAD SHOULD NOT BE DISCONNECTED IN ANY CIRCUMSTANCE.



18. Correct disposal of this product: This symbol indicates that this product must not be disposed of with household waste, according to the WEEE Directive (2012/19/EU) and your national law. This product should be taken to a collection center licensed for the recycling of waste electrical and electronic equipment (EEE). The mishandling of this type of waste could have a possible negative impact on the environment and human health due to potentially hazardous substances that are generally associated with EEE. At the same time, your cooperation in the correct disposal of this product will contribute to the efficient use of natural resources. For more information about where you can take your waste equipment for recycling, please contact your local city office, or your household waste collection service.

Instructions De Securite Importantes



**ATTENTION: RISQUE DE CHOC ELECTRIQUE.
NE PAS OUVRIR**



Le symbole représentant un éclair fléché dans un triangle équilatéral a pour but d'alerter l'utilisateur de la présence d'une "tension dangereuse" non isolée à l'intérieur du boîtier, pouvant être d'une force suffisante pour constituer un risque d'électrocution.



Le point d'exclamation dans un triangle équilatéral a pour but d'alerter l'utilisateur de la présence d'instructions importantes concernant le fonctionnement et la maintenance, dans la documentation qui accompagne l'appareil.

ATTENTION: Appareils de construction de CLASSE I doit être raccordé au réseau électrique via une prise de courant reliée à la terre.

ATTENTION: Pour éviter toute blessure, cet appareil doit être solidement fixé à la torture, conformément aux instructions d'installation.

1. Lisez ces consignes.
2. Conservez ces consignes.
3. Respectez tous les avertissements.
4. Respectez toutes les consignes d'utilisation.
5. N'utilisez jamais l'appareil à proximité d'un liquide.
6. Nettoyez l'appareil avec un chiffon sec.
7. Veillez à ne pas empêcher la bonne ventilation de l'appareil via ses ouvertures de ventilation. Respectez les consignes du fabricant concernant l'installation de l'appareil.
8. Ne placez pas l'appareil à proximité d'une source de chaleur telle qu'un chauffage, une cuisinière ou tout appareil dégageant de la chaleur (y compris un ampli de puissance).
9. Ne supprimez jamais la sécurité des prises bipolaires ou des prises terre. Les prises bipolaires possèdent deux contacts de largeur différente. Le plus large est le contact de sécurité. Les prises terre possèdent deux contacts plus une mise à la terre servant de sécurité. Si la prise du bloc d'alimentation ou du cordon d'alimentation fourni ne correspond pas à celles de votre installation électrique, faites appel à un électricien pour effectuer le changement de prise.
10. Installez le cordon d'alimentation de telle façon que personne ne puisse marcher dessus et qu'il soit protégé d'arêtes coupantes. Assurez-vous que le cordon d'alimentation est suffisamment protégé, notamment au niveau de sa prise électrique et de l'endroit où il est relié à l'appareil; cela est également valable pour une éventuelle rallonge électrique.
11. Utilisez exclusivement des accessoires et des appareils supplémentaires recommandés par le fabricant.



12. Utilisez exclusivement des chariots, des diables, des présentoirs, des pieds et des surfaces de travail recommandés par le fabricant ou livrés avec le produit. Déplacez précautionneusement tout chariot ou diable chargé pour éviter d'éventuelles blessures en cas de chute.

13. Débranchez l'appareil de la tension secteur en cas d'orage ou si l'appareil reste inutilisé pendant une longue période de temps.
14. Les travaux d'entretien de l'appareil doivent être effectués uniquement par du personnel qualifié. Aucun entretien n'est nécessaire sauf si l'appareil est endommagé de quelque façon que ce soit (dommages sur le cordon d'alimentation ou la prise par exemple), si un liquide ou un objet a pénétré à l'intérieur du châssis, si l'appareil a été exposé à la pluie ou à l'humidité, s'il ne fonctionne pas correctement ou à la suite d'une chute.
15. N'exposez pas cet équipement au fait de tomber goutte à goutte ou au fait d'éclabousser et gardez-le au sec. Ne remplissez pas de liquides, comme les vases, n'est placé sur l'équipement.
16. Pour complètement débrancher cet équipement de la conduite principale de courant alternatif, débranchez la corde de pouvoir du disjoncteur de conduite principale.
17. Cette unité est correspondue avec une corde de pouvoir de 3 fils. Pour les raisons de sécurité, L'AVANCE DE TERRE NE DEVRAIT ÊTRE DÉBRANCHÉE DANS AUCUNE CIRCONSTANCE.



18. Mise au rebut appropriée de ce produit: Ce symbole indique qu'en accord avec la directive DEEE (2012/19/EU) et les lois en vigueur dans votre pays, ce produit ne doit pas être jeté avec les déchets ménagers. Ce produit doit être déposé dans un point de collecte agréé pour le recyclage des déchets d'équipements électriques et électroniques (EEE). Une mauvaise manipulation de ce type de déchets pourrait avoir un impact négatif sur l'environnement et la santé à cause des substances potentiellement dangereuses généralement associées à ces équipements. En même temps, votre coopération dans la mise au rebut de ce produit contribuera à l'utilisation efficace des ressources naturelles. Pour plus d'informations sur l'endroit où vous pouvez déposer vos déchets d'équipements pour le recyclage, veuillez contacter votre mairie ou votre centre local de collecte des déchets.

Declaration Of Conformity

We, the manufacturer:

**XTA Electronics Limited,
The Design House
Vale Business Park
Worcester Road
Stourport on Severn
Worcestershire
England
DY13 9BZ**

acknowledge our responsibility that the following products:

**Kind of equipment: Audio Amplifier
Commodity Code: 8518408990
Type Designation: APA-4E8, APA-4E6**

is manufactured:

in accordance with EMC Directive 2004/108/EC,
in compliance with the following norm(s) or document(s):
Technical Regulations: EN55103-1:1996, EN55103-2:1996

and

in accordance with the Low Voltage Directive 2006/95/EC,
in compliance with the following norm(s) or document(s):
Technical Regulations: EN/IEC60065:2002 7th Edition

Signed:



Name: Alex Cooper
Position: Research and Development Manager
Date: May 2017



Installing your APA:

Unpacking

After unpacking the unit, please check it carefully for any damage. If any is found, immediately notify the carrier concerned - you, the consignee, must instigate any claim. Please retain all packaging in case of future re-shipment.

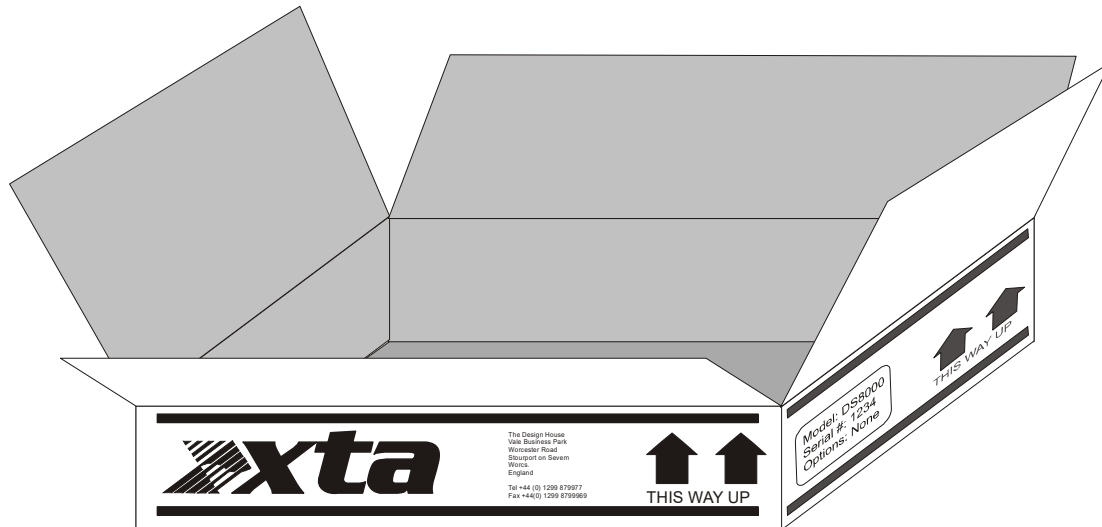

Additional Symbols and Warnings



只有在高海拔地区使用不超过2000米。

Meaning of the symbol: Evaluation for apparatus only based on altitude not exceeding 2000m, therefore it is the only operating condition applied for the equipment. There may be some potential safety hazard if the equipment is used at altitude above 2000m.



只适合于非热带气候地区使用

Meaning of the symbol: Evaluation for the apparatus only based on temperate climate condition, therefore it is the only operating condition applied for the equipment. There may be some potential safety hazard if the equipment is used in tropical climate region,

Installing Your APA:

Electrical Considerations

The amplifier is fitted with a universal power supply which will operate world-wide – no user setting is required.

Make sure power outlets conform to the power requirements listed on the back of the unit. Damage caused by connecting to improper AC voltage is not covered by the warranty.

SAFETY WARNING

Where a MAINS plug or appliance coupler is used as the disconnect device, it should remain readily operable.

Where the amplifier is mounted in a rack and permanently connected to the mains, then the rack should be installed with a readily accessible connector or an ALL POLE circuit breaker with 3mm breaking distances.

For PERMANENTLY CONNECTED APPARATUS provided neither with an all-pole MAINS SWITCH nor an all-pole circuit breaker, the installation shall be carried out in accordance with all applicable installation rules.

For safety reasons,

THE EARTH LEAD SHOULD NOT BE DISCONNECTED IN ANY CIRCUMSTANCE.

If ground loops are encountered consult the section on connecting your amplifier on page 14.

The wiring colours are:

230V AREAS: EARTH = GREEN AND YELLOW
NEUTRAL = BLUE
LIVE = BROWN

120V AREAS: EARTH = GREEN
NEUTRAL = WHITE
LIVE = BLACK

DO NOT USE THE UNIT IF THE ELECTRICAL POWER CORD IS FRAYED OR BROKEN. The power supply cords should be routed so that they are not likely to be walked on or pinched by items placed upon or against them, paying particular attention to cords and plugs and the point where they exit from the appliance.

ALWAYS OPERATE THE UNIT WITH THE AC GROUND WIRE CONNECTED TO THE ELECTRICAL SYSTEM GROUND. Precautions should be taken so that the means of grounding of a piece of equipment is not defeated.

DO NOT REMOVE THE LID. Removing the lid will expose you to potentially dangerous voltages. There are no user serviceable parts inside.



Installing Your APA:

Mechanical Considerations

To ensure that your APA performs to specification, it should be mounted in a suitable rack or enclosure as described below. Like all high power amplifiers, it should be kept away from other equipment which is sensitive to magnetic fields. Also, this amplifier may suffer a substantial reduction in performance if it is subjected to, or mounted close to equipment which radiates high RF fields.

Warning: To prevent injury, this apparatus must be securely attached to the rack in accordance with the installation instructions.

When mounting the amplifier in a rack or enclosure:

Be aware that...

THE FRONT PANEL IS NOT CAPABLE OF SUPPORTING THE UNIT ON ITS OWN.

Make sure that the rear of the unit is adequately supported. The depth of the front panel relative to the front of the rack may be adjusted by moving the side panel supports.

ENSURE THERE IS ADEQUATE VENTILATION.

The cooling fans suck cool air in through the front and blow hot air out at the rear of the unit through the ventilating grills. The front and rear of the amplifier should have free exposure to the air (i.e. in a rack leave the front & rear doors off), with 2cm air gap at the sides.

IF AIR IS NOT ALLOWED TO ESCAPE FROM THE REAR, OVER-HEATING WILL OCCUR.

Take care when mounting other equipment in the same rack.

Make sure that the rack unit has a separate earth connection (technical earth).

Please also see the notes regarding maintenance on page 64.



Connecting To Your APA:

Audio Inputs Wiring

Inputs - The inputs are made via 3-pin XLR connectors, which are electronically balanced and should be connected via a high grade twin core screened cable, as follows:

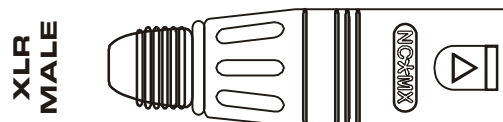

PIN1: Screen (see NOTE)
 PIN2: Hot (signal +)
 PIN3: Cold (signal -)

The amplifier is designed to operate with fully balanced equipment and ground loops or loss of performance may be experienced if connected to unbalanced sources. If it is unavoidable however, the following wiring should be used. The cable should still be twin core plus screen.

PIN1: Screen - connected to the chassis of the unbalanced equipment - or left disconnected at the unbalanced end.
 PIN2: Hot (signal +)
 PIN3: Cold (ground 0V)

NOTE: This amplifier is wired to the latest industry recommendations. PIN1 is connected directly to the chassis/mains earth. If ground loops (mains hum) are encountered remove the screen connection from the one end of the cable and leave it open circuit. If problems persist, consult your dealer/supplier.

DO NOT TAMPER WITH OR ALTER ANY GROUND (EARTH) CONNECTIONS INSIDE THE AMPLIFIER.

RS485 Output Wiring

The RS485 output is a data port for connection to other XTA equipment only. It is currently not supported, however for reference, the following wiring should be used:

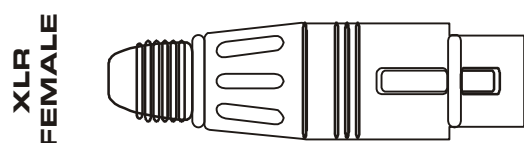

PIN1: Screen (see NOTE)
 PIN2: Hot (signal +)
 PIN3: Cold (signal -)

Speaker Outputs Wiring

The speaker outputs are via Neutrik Speakon connectors. 2 pole (NL2FC) or 4 pole (NL4FC) connectors can be used.

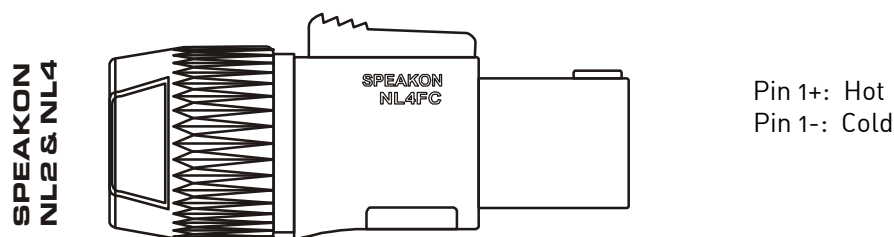

Additionally Channel 1 Speakon connector carries Channel 2 output on Pins +2 & -2 to allow easy bi-amping or bridged operation using a single NL4 connector.

Pin 2+: Hot Ch. 2
Pin 2-: Cold Ch. 2

In the same way, channel 3's Speakon carries channel D on 2+ and 2-.

There must be no shared connections between channels.

The minimum load per single channel is 2 ohms. XTA recommend running channels with a minimum 2.7 ohm load for maximum efficiency and long term power delivery (3 x 8 Ohm loads in parallel).

As the currents involved are very high, and to ensure best performance, the speaker cables should be kept as short as possible and conform to the following minimum requirements:

APA-4E8: 22 Amps into 4 Ohm speaker loads.

APA-4E6: 13 Amps into 4 Ohm speaker loads.

When operating the amplifier into loads of less than 4 Ohms, be aware that the current capacity of the speaker cables will need to be increased above the values quoted above.

Do not connect the inputs/outputs to any other voltage source such as a battery, mains source or power supply, regardless of whether the amplifier is turned on or off.

Do not run the output of any amplifier channel back into another channel's input and do not parallel or series-connect an amplifier output with any other amplifier output.

Connecting To Your Amplifier: Bridged (Mono) Operation

Use Channel 1 or 3 Output Speakon connector and connect as follows:

Pin 2+: Hot
Pin 1-: Cold

When operating in bridged mode, the minimum impedances are doubled.

The minimum load in bridged mode is 4 ohms.



Getting To Know Your APA:

Front Panel Layout and Controls

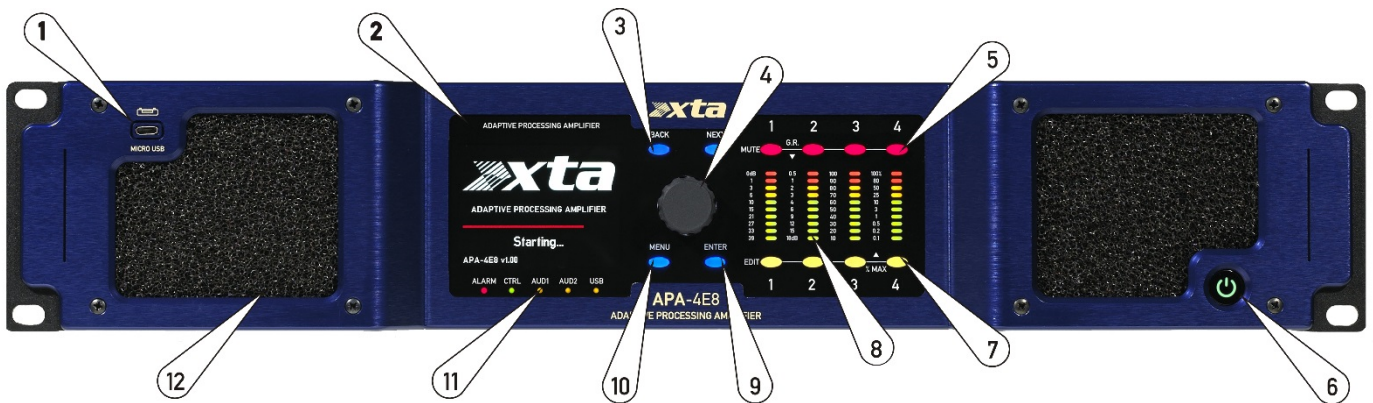

1: USB 'OTG' Socket: APA works in Host mode, so USB memory sticks can be plugged in here to update firmware, download presets, save log files, and upload EVAC playout messages. Please see notes on page 40 for more information.

2: LCD Screen: This full colour display primarily operates in black and white, only showing warnings in red – at a glance if you see no colour then you can be sure your APA is operating normally!

3: Back and Next Navigation Keys: From the Home Screen, these will cycle through various "User Metrics" detailing the amplifier's performance and current status – please see page 30 for more information on the "User Metrics". They are also used to navigate the main menu system and output menus.

4: Velocity Sensitive Encoder: Used to alter parameter values, and may also be used to cycle through "User Metrics" from the Home Screen.

5: Mute Keys: These will mute the output channel processing sections of the amplifier. They do not affect input processing or audio sent back out on the network. Please refer to the system block diagram on page 22 for more information.

6: Standby/Home Key: If illuminated RED then the amplifier is in standby (no display shown but DSP is still active and amplifier is still available on the network). Press and hold for 3 seconds to power up. A three second press will also put the amplifier into standby. Use as a quick "Exit" from any menu to get back to the Home Screen and User Metrics.

7: Output Edit Keys: These directly access output channel gains, as well as other output related information such as limiter thresholds, polarity switching, and current preset information.

8: Tri-colour metering: As all meter elements can display green, yellow or red, APA can show many different things on the meters. Default meter mode shows output channel dB from limit. More information on page 36.

9: Enter Key: Used to confirm selections and enter sub-menus where appropriate.

10: Menu Key: Press to access system wide parameters and specific sub-menus.

Front Panel Layout and Controls cntd...



- 11: Status and Warning Indicators: Permanent indication of the following:
- ALARM: Illuminates to show any condition APA needs to warn you about – the list of possible warnings is covered on page 59.
 - CTRL: Illuminates when a connection is made from the CTRL (control) Ethernet socket on the rear panel, to a valid network.
 - AUD1: Illuminates when a connection is made from the AUD1 (audio) Ethernet socket on the rear panel, to a valid network.
 - AUD2: Illuminates when a connection is made from the AUD2 (audio) Ethernet socket on the rear panel, to a valid network.
 - USB: Illuminates when a USB stick is connected and data is being transferred. Do not disconnect USB device if LED is flashing.

12: Air Vents: The amplifier draws air in from the front and exhausts from the back. Please ensure there is adequate ventilation space front and back – see page 64 for more information on looking after your amplifier.

Rear Panel Controls and Sockets

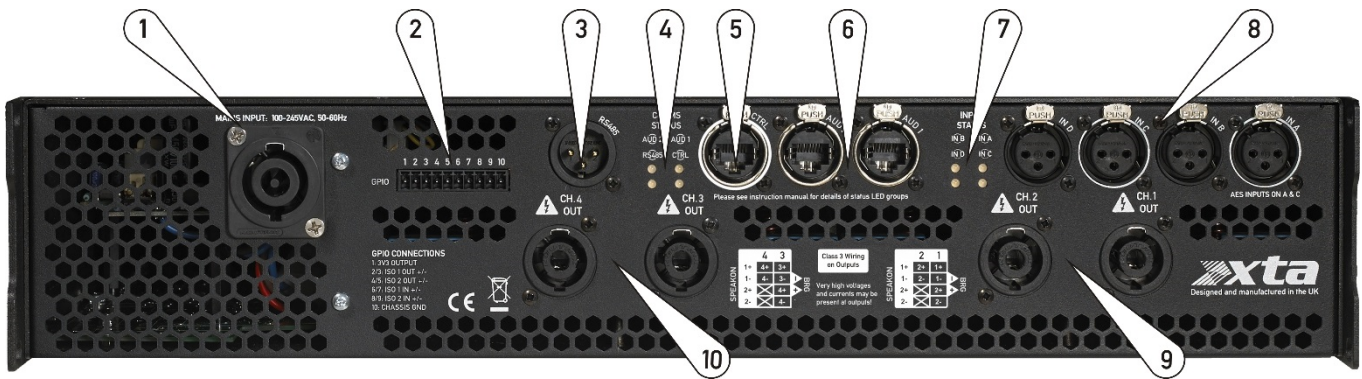

1: Mains Input Socket: Mains connection is via a 32A "Powercon" type plug. Supply voltage is 100-240V AC. This unit must be earthed.

2: GPIO Socket: Connections are via Phoenix "mini" connectors. They can be used to provide feedback of fault conditions, as well as being used to trigger different amplifier events such as mutes, standby, and emergency evacuation message playback. Please see page 19 for more information on the current capabilities.

3: RS485 Output Socket: This socket is intended for diagnostics only. It is not intended to be used as a method of primary remote control of this amplifier. Please see page 14 for more information.

4: Comms Status LEDs: This group of 4 tricolour LEDs shows if the current Ethernet and RS485 comms ports are connected and in use. More information on their various modes of operation is given on page 19.

5: CTRL Ethernet Socket: This RJ45 socket connects the amplifier to a valid Ethernet network for remote control and monitoring.

6: AUD1 & AUD2 Ethernet Sockets: This pair of RJ45 sockets connect the amplifier to a valid Ethernet network for transmission of audio data.

7: Input Status LEDs: This group of 4 tricolour LEDs can show various information about signal level or lock status in AES mode. Please see page 19 for more information.

8: Analogue and AES Digital Input Sockets: By default these four sockets are four analogue inputs, but individual pairs of sockets can be switched (via remote software and memory recall via the front panel) to receive AES digital audio. AES input on channel A's XLR provides a stereo stream designated AES A + AES B; AES input on channel C's XLR provides a stereo stream designated AES C + AES D. When an AES input is selected, the "other" channel of the pair is disabled (you cannot input analogue into channel B XLR if A&B are set to AES mode).

9: Speaker Output Sockets 1&2: The primary speaker outputs are via Neutrik Speakon connectors on 1+ and 1-. Two pole (NL2FC) or four pole (NL4FC) connectors can be used. Additionally Channel 1 Speakon connector carries Channel 2 output on Pins +2 & -2 to allow easy bi-amping or bridged operation using a single NL4 connector.

10: Speaker Output Sockets 3&4: The primary speaker outputs are via Neutrik Speakon connectors on 1+ and 1-. Two pole (NL2FC) or four pole (NL4FC) connectors can be used. Additionally Channel 3 Speakon connector carries Channel 4 output on Pins +2 & -2 to allow easy bi-amping or bridged operation using a single NL4 connector.

Rear Panel Status LED Groups

There are two sets of status LEDs on the rear panel – one set beside the input XLR sockets and one set beside the network sockets. Both sets are tri-colour LEDs and so can show a variety of information using colour and steady/flashing indication as explained below.

The input status LEDs show both analogue signal present and approaching clipping point, and AES lock status and sample rate.

In analogue input mode, the corresponding input channel's LED will be off in the absence of signal and will show signal present in green and 1dB below clip in red.

- Input level too high – above +18dBu and approaching clipping point of input!
- Analogue signal present above -60dBu – all OK
- No analogue signal present, or below -60dBu

In AES input, indicators for inputs A and C will show digital input status and sample rate. The choice of AES or analogue may be selected remotely on a pair-by-pair basis, so A&B can still be showing analogue level, with C showing digital status for the C&D AES stream, and vice versa.

- ● ● Flashing red – AES input active, no signal lock (so no audio!)
- Steady red – locked to 48k AES stream
- Steady yellow – locked to 96k AES stream (ideal)
- Steady green – locked to 192k AES stream

GPIO Connections

The amplifier is equipped with a 10 way mini-Phoenix type connector that offers a pair of logic level inputs for triggering different aspects of APA's operation, and a pair of logic level outputs for simple remote reporting on various statuses.

It is wired as follows:

- 1: 3V3 OUTPUT
- 2/3: ISO 1 OUT +/-
- 4/5: ISO 2 OUT +/-
- 6/7: ISO 1 IN +/-
- 8/9: ISO 2 IN +/-
- 10: CHASSIS GND

Currently emergency wav file playback from the SD card is offered, but this feature set will be enriched in later firmware releases. Please see the section about the SD card file structure and wav file format on page 40.



Signal Paths and Block Diagram



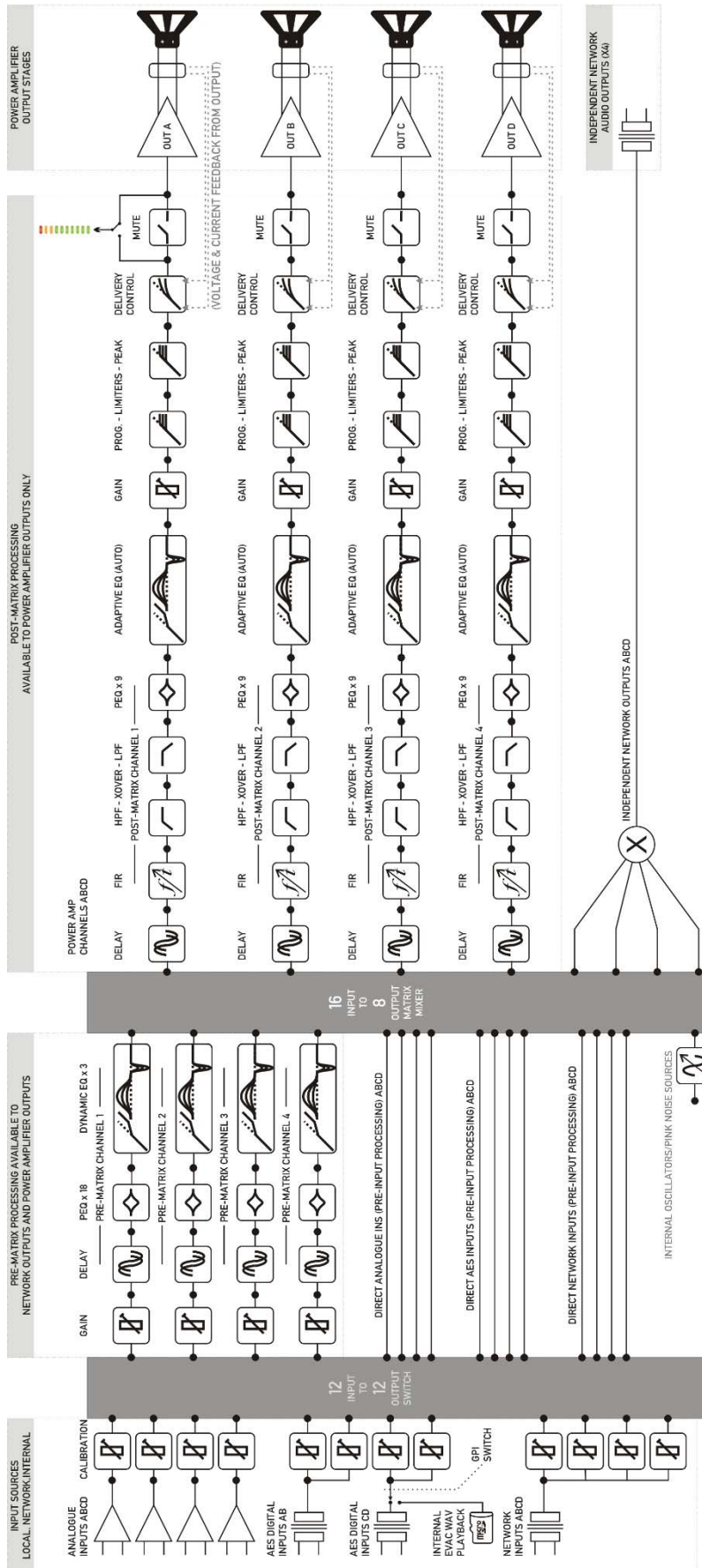

Input Sources

APA is exceptionally flexible as regards input routing and mixing, and can receive audio from a variety of sources: analogue audio, stereo AES audio, multichannel networked audio, along with internal noise and sine wave generators and audio file playback from the internal SD card (for emergency evacuation messages only).

With the exception of the internal oscillators, all the other audio sources are available on the input side of the 12 x 12 **switched** routing matrix.

The four DSP "Input" processing channels, can receive signals from any of the available signal sources but please note the following:

- As AES inputs share physical XLR connection with two analogue inputs, you cannot source analogue input A and AES A at the same time. This is also true for analogue source C and AES C.
- AES C+D shares an input to the switching matrix with mono "wav" file playback for emergency evacuation messaging. This is enabled by either a contact closure on the local amplifier, or by a network message. Please see the section on page 54 for more information.

AES Inputs

APA can accept a pair of AES3 digital audio streams in stereo channel pairs. As explained in the section above, these share the physical connectors for analogue inputs A and C for the two digital inputs. They can be selected on a channel pair basis so one pair of digital and one pair of analogue inputs can be in use together if required.

The AES inputs accept sample rates from 32kHz up to 192kHz, at 24 bit resolution. In AES input mode, rear panel indicators for inputs A and C will show digital input status and sample rate.

- ✶ ● ✶ Flashing red – AES input active, no signal lock (so no audio!)
- Steady red – locked to 48k AES stream
- Steady yellow – locked to 96k AES stream (ideal)
- Steady green – locked to 192k AES stream

Via the Quick Inputs Monitor on the front panel, the AES input levels can be verified by selecting Quick Inputs Monitor using BACK and NEXT from the home screen and then turning the encoder to select AES Inputs:

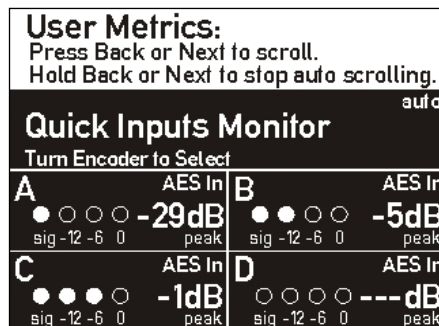

Pre-Matrix Processing

APA's processing is conveniently split between input signal conditioning before it reaches the full mix matrix, and output/loudspeaker specific processing dedicated to each of the four power amplifier channels.

With this in mind, the pre-matrix processing has been designed to offer as much flexibility as possible, as it may be used for network audio processing that does not involve the local power amplifier at all. For example – the amplifier may be configured to run a 4-way system, as one half of a stereo set-up. This would mean that three of the four available input processing paths would remain unused. This need not be the case of course, as they can be utilised to process incoming audio from another source, and output this on the network.

The diagram below illustrates this example.

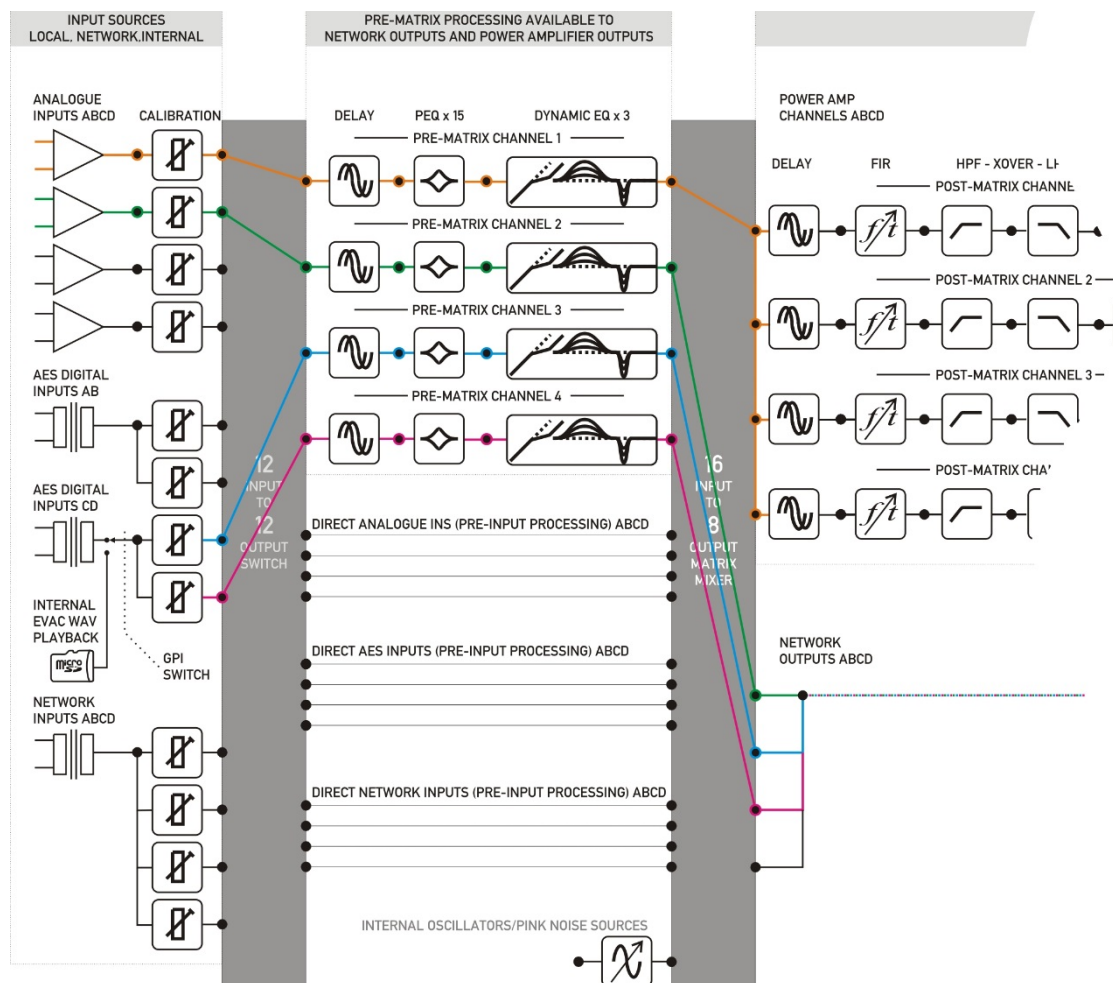

In this example, analogue input A is feeding all four post-matrix processing channels (to the local power amplifiers) with analogue input B being processed but not connected to any further local processing, instead being fed back out onto the network for use elsewhere. Similarly, AES input stream C&D is picked up and processed before being sent back out onto the network.

Processed Input Channel Blocks

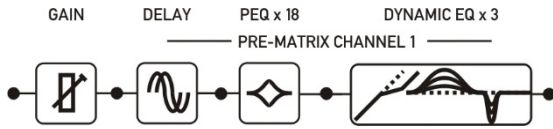

Each processed input channel contains the following blocks:

Gain: the input level to the processing channel (pre-matrix) may be trimmed to adjust the level up-stream of any output processing or network outputs.

Delay: over 1000mS available on each input channel in 0.01mS steps.

Remember that this delay will affect all outputs that it feeds – those might be local power amplifier channels and/or network outputs.

PEQ EQ: 18 bands of parametric equalisation are available on each input channel. Each band is switchable to a wide variety of filter topologies including:

- Standard parametric EQ;
- Low Shelving;
- High Shelving;
- Low Pass (including adjustable 'Q'/slope);
- High Pass (including adjustable 'Q'/slope);
- All Pass (including adjustable 'Q'/phase shift);
- Phase (90 degree shift with adjustable frequency);
- Notch;
- Bandpass.

The operation and use of these different types is covered in Appendix III starting on page 80.

Dynamic EQ: 3 bands of DEQ are available on each input channel.

Each band can be set to operate in four modes:

- Boost above threshold (upward expansion);
- Cut above threshold (standard downward compression);
- Boost below threshold (upward compression);
- Cut below threshold (standard downward expansion).

Additionally, the filter's type can be switched between operating as a standard parametric EQ, to a high or low shelving filter, or run full range, whereupon the filtering behaviour is disabled, and the DEQ band operates as a compressor/expander as determined by the mode.

The operation and use of the dynamic EQ is covered in Appendix I starting on page 70.

Mix Matrix to Power Amp Processing Channels / Network Outputs

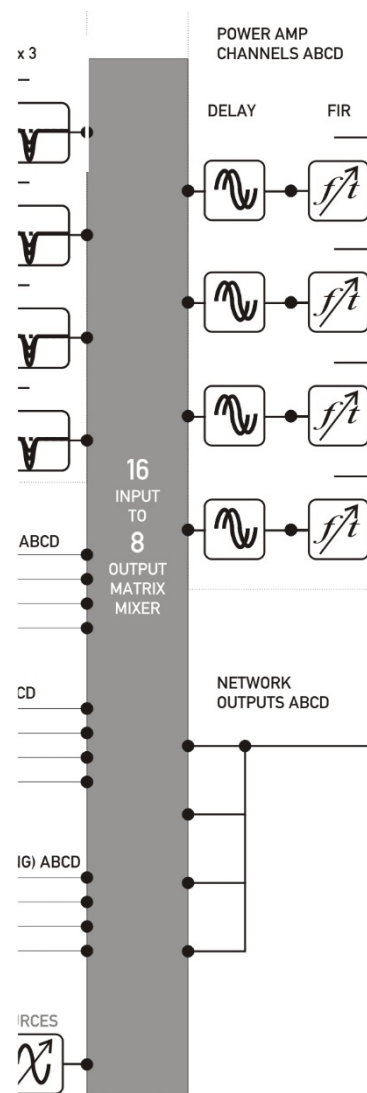

Following the input switching and before the power amplifier processing and network outputs, the mix matrix allows full mixing of up to 16 sources to each of the 8 outputs.

- The 16 sources are derived from:
- Processed input channels x 4;
 - Direct analogue inputs x 4;
 - Direct AES digital inputs x 4;
 - Network audio inputs x 4.

The 8 outputs are to the four further processing channels connected directly to the power amplifiers, and four network audio outputs that can then be used externally to the amplifier by other devices (not just APA).

Note that this is a full mix matrix – different to the input switcher – signals from any source can be mixed if required.

The remote software presents this as two independent sets of “sends” – one page for the local power amps and one for the network outputs. This is because there are two modes of set-up:

- A “crosspoint” matrix with Boolean on/off choices in a grid, with associated automatic adjustment of gains to maintain 0dB at the output (so for example sending two channels to an output will drop their respective send gains by 3dB so they sum to 0dB).
- An advanced mix matrix with all sources having fully adjustable gains.

Power Amp Channels Processing Blocks

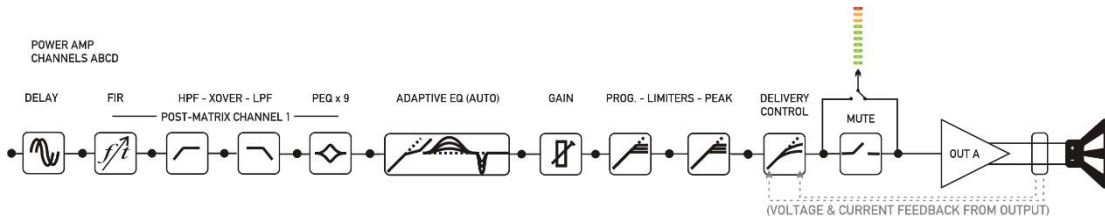

Each power amplifier channel contains the following blocks:

Delay: over 1000mS available on each input channel in finer sub-sample 300nS steps. This delay normally is used for driver time alignment and so works at very high resolution: a 300nS step size equates to a distance adjustment of 0.1mm.

FIR Filtering Block: FIR filtering coefficient data may be loaded into this section (when designing a preset for the output channel) which can be used to equalise the signal path instead of using the IIR filters (that is, the crossover filters and PEQ sections). It can also be used in addition to these filters to linearise the phase response for the channel. Used in this way, it gives the flexibility of real time adjustment of all EQ, as well as guaranteeing linear phase, and with lower latency than standard "linear phase" filters.

Crossover Filters: Slopes from 6dB/Octave up to 48dB/Octave may be chosen with standard filter topologies Bessel, Butterworth, and Linkwitz Riley. The high and low pass filters are independent so allowing for asymmetrical crossovers to be realised.

PEQ EQ: 9 bands of parametric equalisation are available on each input channel. Each band is switchable to a wide variety of filter topologies including:

- Standard parametric EQ;
- Low Shelving;
- High Shelving;
- Low Pass (including adjustable 'Q'/slope);
- High Pass (including adjustable 'Q'/slope);
- All Pass (including adjustable 'Q'/phase shift);
- Phase (variable 180 degree shift with adjustable frequency);
- Notch;
- Bandpass.

Note that 48dB slope crossover filters will bypass two bands of PEQ each.

The operation and use of these different types is covered in Appendix III, starting on page 80.

Adaptive EQ: These two bands of dynamic EQ are hidden from the user and are automatically set up and adjusted by the amplifier during "adaptive" operation. This functionality will be increasingly enabled in a future release.

Gain: Individual output channels' gain trim allows driver level differences to be incorporated into preset data and can be further adjusted by the user (if permitted). The front panel gain trim also works at this point (but is separate from this).

Program (RMS) Limiter: The program limiter is designed to control the continuous level and limit the long term level to a driver to prevent overheating of a driver voice coil. The look-ahead design of the program limiter means that it can accurately detect signals that will exceed its threshold and apply gain reduction to them whilst still applying the desired attack time. Attack and release time constants may be automatically set, if desired, according to the high pass crossover frequency for a particular channel.

Peak Limiter: The peak limiter is the last processing block in the signal path and will catch any peaks that the program limiter lets through, due to its (desirable) variable attack time. With this use in mind, the threshold adjustment for the peak limiter is set in "dB above" the program limiter and it will track the threshold of the program limiter as it is adjusted, always sitting at the required number of dB above it. It is designed to limit over excursion of drivers, in particular LF drivers, and prevent mechanical damage caused by this.

For more information on how the limiters work, please see Appendix II, starting on page 74.

Delivery Control: This is a sophisticated feedback system that measures the real time voltage and current being delivered to the actual output load. Using the same quality 24 bit 96k analogue to digital converters as employed at the analogue inputs, the voltage and current (and so the power and impedance) may be calculated and used to model the heating effects on a driver. The long term power delivery may then be adapted to prevent overheating or premature failure of the speaker. This system's parameters are defined by the speaker manufacturer in the preset (along with the usual crossover points, EQ etc.) and may not be visible to the end user.

Channel Mute: front panel mute controls operate at this point in the signal path, just before the power amplifiers.



Operating Your APA:

Powering Up

Your APA will power up in standby the first time it is connected to the mains supply. The Power/Home button will be illuminated red. A brief press on the Power/Home button will wake up the display and meters for 5 seconds allowing you to check levels, IP address, and operate mutes if you need to adjust these before you switch on.

This Amplifier is:	
SUBS FAR LEFT STAGE	
Unit memory running is: 21" Infrass + 18" LMX	
Status: Hold POWER to turn on	
IP:192.168.45.14	Unit ID: 01 35 45 F4 5B

To power up, hold the Power/Home button for 3 seconds – the display will wake up and you will see the countdown on screen:

This Amplifier is:	
SUBS FAR LEFT STAGE	
Unit memory running is: 21" Infrass + 18" LMX	
Status: Powering up in 3...	
IP:192.168.45.14	Unit ID: 01 35 45 F4 5B

The Power /Home button will change to green and the amplifier will start its power up sequence:

- 1) Delaying for a random period (less than 2 seconds) to prevent multiple amplifiers all powering up together under remote control causing excessive current draw
- 2) Checking and enabling the power supply
- 3) Checking and enabling each output channel and relay
- 4) Finally, unmuting the DSP and fading up the audio

Once this sequence is complete, the amplifier will show its home screen:

This Amplifier is:	
SUBS FAR LEFT STAGE	
Unit memory running is: 21" Infrass + 18" LMX	
Status: OK	
IP:192.168.45.14	Unit ID: 01 35 45 F4 5B



Hint: During start-up, the mute button LEDs will flash if they are going to unmute automatically at the end of the sequence. They are active during the entire start-up sequence and can be muted/unmuted at any time if not set as required.

Powering Down and Returning Home

Powering down also requires a 3 second hold on the Power/Home button. A brief press of the Power/Home button whilst the amplifier is active will return to the home screen, and also display the hint about how to power down:

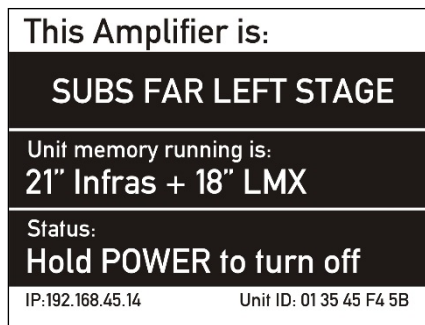

Hold Power/Home for 3 seconds to see the countdown, at which point the amplifier will go into standby and the output relays will disengage, and the main power supply (PSU) will power down. The display will briefly show:

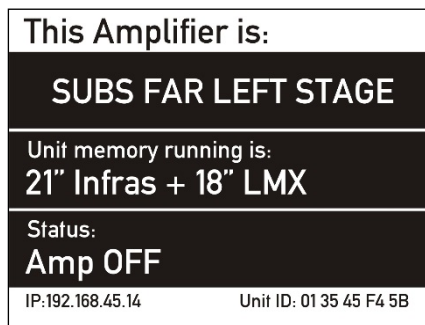

Before the screen and all indicators and meters are extinguished. The Power/Home button will change to red.

*Hint: If you wish to leave the screen and metering active in standby, hold the MENU button and **briefly** press Power/Home when the amplifier is in standby. Another press of Power/Home will clear this. This mode is useful for checking presets or setting mains current limits before powering the amplifier up fully.*

It is also a requirement that USB access for syncing presets and uploading of new firmware is only possible in standby to avoid potentially dangerous mistakes!



Home Screen Layout

The home screen shows you important useful information about your APA.

This Amplifier is:	
SUBS FAR LEFT STAGE	
Unit memory running is: 21" Infrass + 18" LMX	
Status: OK	Security level: 0 (Full Access)
IP:192.168.45.14	Unit ID: 01 35 45 F4 5B

The name of your APA as it appears on the network control software is shown first. If you've not chosen a name APA will give it a random one so it can be easily identified if you have multiple amplifiers on the network.

The next section shows the name of the current user memory or, "None" if one is not being used.

The next section down is the status bar which will display any important information about the "health" of your APA, as well as hints about operation and the current security level – see page 58 for how this works.

At the bottom of the screen the amplifier's IP address and Unit ID are shown. The IP address will be assigned to the amp by your network's DHCP server – if you want a direct 1:1 connection to a laptop and cannot connect to a server, then the amplifier can generate its own local IP address. Please see the section about connecting to a network, starting on page 61.

The "Monochrome Concept"

To make your APA as intuitive and simple as possible to operate, we have designed the user interface to be useful from a distance as well as up close. This design concept extends from the information shown on the LCD to the metering and its various modes. Considering the LCD in this case, you may not be aware that the LCD is a full colour QVGA display. We choose to show all information in black and white as it offers the best contrast and readability.

To highlight any conditions that will result in a loss of audio or reduction in performance, we solely use red on the display. In this way it is easy to confirm, from any distance, if there are any things that require user intervention or attention. If the amplifier is operating normally and all channels are able to output audio, you will never see any colour on the display.

Similarly with the metering – red LEDs are only used when there is an automatic reduction of level in a channel, or a fault condition.

To summarise - no red = no worries!

User Metrics

Incoming Mains Monitor

Your APA uses high resolution converters to measure the incoming mains voltage and instantaneous current draw so that it can adjust output power levels if you have set a current limit, and also to ensure that the mains voltage remains within the safe operating range of the unit.

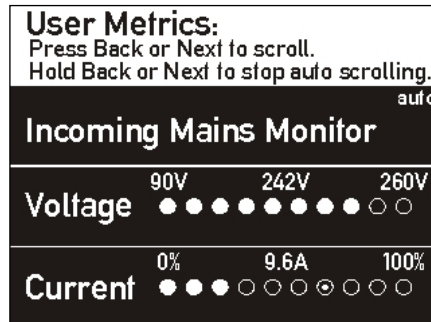

Peak current is shown as a held dot within the current meter. If the mains voltage drops too low for satisfactory operation, or goes too high for safe operation, the voltage portion of the screen will change to red, and the ALARM LED on the front panel will illuminate. Depending on how low the mains voltage drops, the amplifier may go into full protection and disable the outputs until the condition has cleared or been remedied.

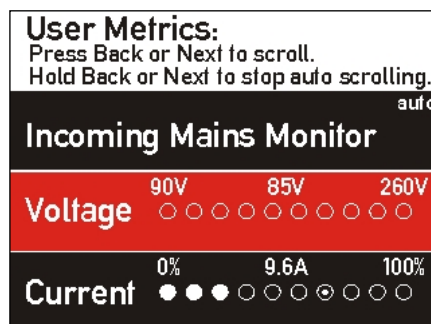

If the current draw of the amplifier begins to exceed the user set limit (see page on page 54 for how to do this) the current meter will additionally display how much gain reduction is being automatically applied to stay operational and keep playing.

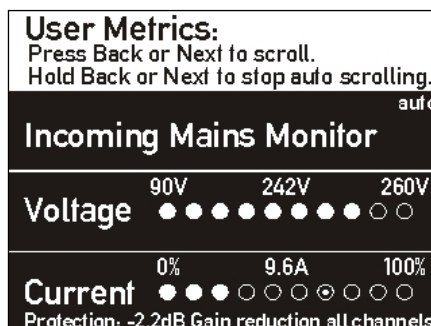

Note that protection information will only be displayed if below the speaker protection limiter thresholds.



Amplifier Temperatures

Your APA has over 20 temperature sensors, monitoring several points on each individual channel's circuitry, as well as various points within the power supply, and the output filters. This data is all used to ensure that the amplifier can adapt its behaviour to stay operational and keep playing as long as possible.

An algorithm uses this data to create an overall "temperature" of the amplifier and this is displayed along with the power supply temperature.

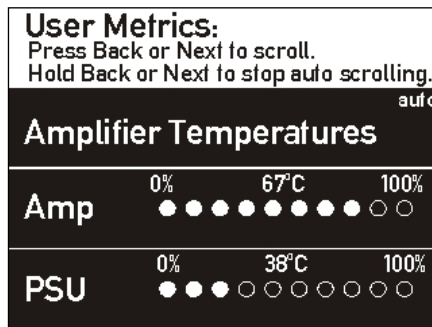

Should the amplifier's temperature rise to a dangerous level, the relevant portion of the screen will change to red and the ALARM LED on the front panel will illuminate.

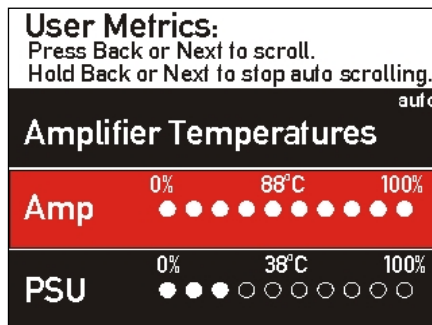

Individual channels' temperatures can cause the amplifier to apply protection on a channel by channel basis to prevent overall shut down protection and keep playing as long as possible. The display will show applied gain reduction if this is operating below the speaker protection limiter thresholds.

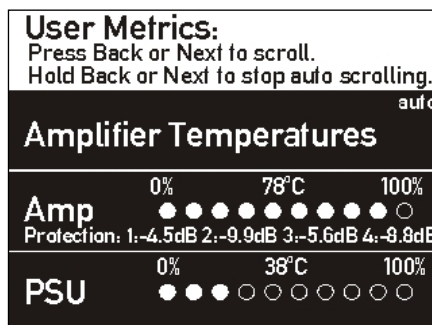

As this operation may affect the frequency balance of your system (for example bass drivers being reduced in level relative to mid-high drivers), you can minimise this happening by ensuring adequate cooling and adhere to minimum load specifications as detailed on page 15 of this manual.



Quick Inputs Monitor

The LED meters on your amplifier always show levels relating to the power amplifier outputs, be this absolute output level, level relative to the limiter, or compressor gain reduction¹. However, you can also check the incoming levels using this metric display.

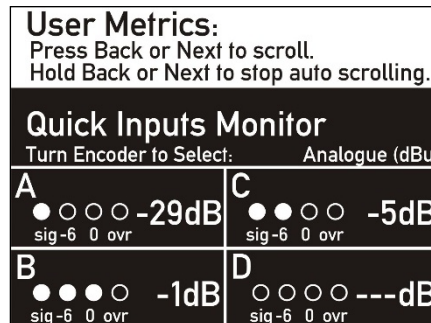

All four inputs of the selected type are displayed at the same time, with real time bar metering and numerical readout. Select the input type by turning the encoder when on this screen, and choose between analogue inputs as above, or AES inputs, or network inputs.

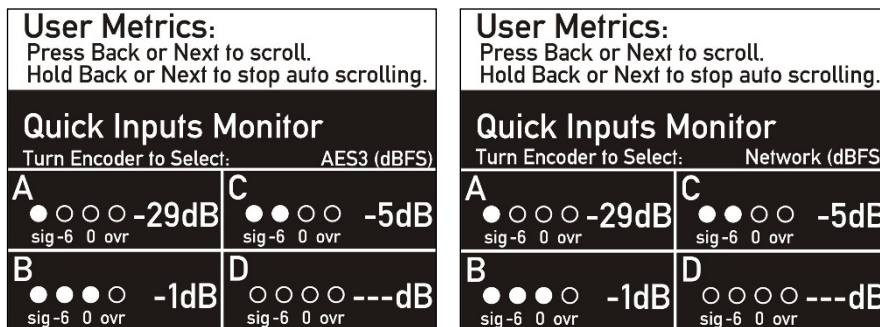

Note that this is NOT the method for choosing inputs and switching between them – this is only possible through the remote software or by selecting a unit preset with different input selections. As the AES and Analogue connections are shared, some monitoring scenarios may not always be possible – for example, you cannot monitor AES inputs C&D if Analogue has been switched in. Under these circumstances the screen will show:

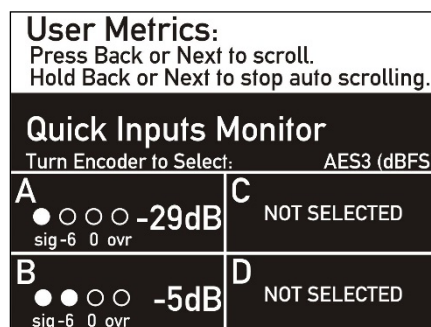

¹ In future firmware releases, compressor gain reduction and power output will be available as metering options



Amp Channel Loads

In addition to the more obvious 24 bit 96k analogue to digital converters (ADCs) fitted to the inputs of your amplifier for analogue signal conversion, your APA has eight additional ADCs of the same quality fitted directly at the output terminals. These are used to monitor the speaker output voltages and currents in real time and are fed directly back into the DSP, so near-instantaneous monitoring of power and distortion can be realised. This hardware addition is crucial to the adaptive nature of your APA.

It also permits real time monitoring of the load impedances using this metric display.

User Metrics: Press Back or Next to scroll. Hold Back or Next to stop auto scrolling.			
Amp Channel Loads <small>auto</small>			
1	2.7Ω	3	2.7Ω
2	4.2Ω	4	7.7Ω

The first time this user metric display is shown after power up, it will display "---" in place of a measured impedance, until voltage and current data at a sufficient level has been collected. This may take a few seconds, and the measurement algorithm is weighted to respond to instantaneous drops in impedance so that over current protection can operate quickly to prevent damage to output circuitry.

User Metrics: Press Back or Next to scroll. Hold Back or Next to stop auto scrolling.			
Amp Channel Loads <small>auto</small>			
1	---	3	2.7Ω
2	4.2Ω	4	---

If the level on any channel drops below the threshold for accurate readings to be taken, the previous value will be held and shown in parenthesis as below, where channels 2 and 4 reads are now not live.

User Metrics: Press Back or Next to scroll. Hold Back or Next to stop auto scrolling.			
Amp Channel Loads <small>auto</small>			
1	2.7Ω	3	2.7Ω
2	(4.2Ω)	4	(7.7Ω)

Auto Scrolling of User Metrics

As explained on each user metrics screen, holding either the BACK or NEXT key for 2 seconds will toggle between auto mode and manual mode. Auto scrolling mode will switch to the next metrics screen every 5 seconds, and will include the home screen in this loop. Auto scrolling enabled is shown by the small "auto" in the top right corner of the metric title area on the display.

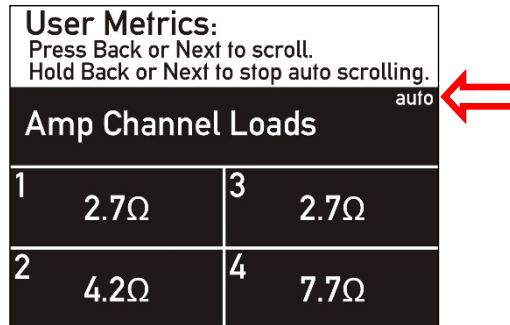

In manual mode, BACK and NEXT do not scroll through the home screen. To return to the home screen, press the Power/Home button briefly.

Tri Colour Panel Metering

The LED metering on the front panel of your APA is made up of tri colour LED elements, capable of displaying red green or yellow. This allows the meters to dynamically alter their colour and offer much better visual feedback.

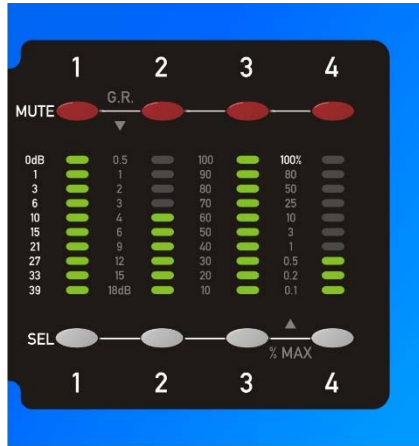

They can be switched to operate in a number of different modes² but the default is to show the power amplifier output levels, pre-mute. The meters are linked to the limiter so that they show a dB level relative to the limiter threshold for each channel, and their ballistics (attack and release times) will reflect those chosen for that channel's limiter.

Adjusting the limiter threshold for a channel will therefore change the metering shown for that channel, and so for a fixed input level, *lowering the limiter threshold will show more level on the meter.*

They also show gain reduction once a channel's level has exceeded the limiter threshold, by changing colour and "wrapping round", beginning to read downward from the top in red. So, the above snapshot shows channels 1 & 3 just on the threshold of limiting with channel 2 having a further 10dB until limit and channel 4 still 27dB from limit.

If the signal increases further, the meter will not simply "stop" at 0dB, but will change to red and begin to light red LEDs from the top down.

Channel 1 has just exceeded the limiter threshold by approximately 0.5dB at this point, and in the third snapshot it's clear that channel 1 and 3 are hard into limit with 4 and 9dB of limiting (gain reduction) respectively. The "G.R." scale shown on the panel between channels 1 & 2 should be used for this purpose.

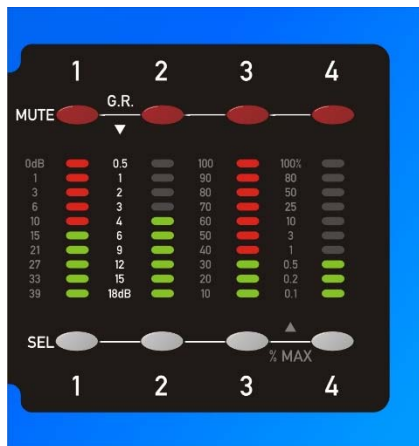
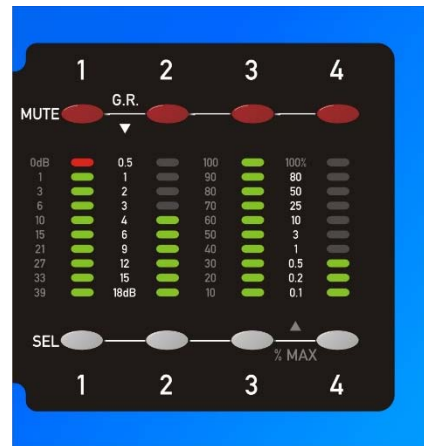

Note that this meter reads PRE-MUTE and so will always show signal even if the channel mute is enabled.

² In future firmware releases, compressor gain reduction and power output will be available as metering options



Output Channel Menu

Overview

Pressing one of the output edit buttons allows adjustment and viewing of parameters associated with the power amplifier output channels, including quick gain trim, checking of the limiter threshold and adjustment of the output polarity. The list of output menu options deliberately starts with the quick gain trim, so that it's easy to adjust this with just a single button press. Navigation through the list is with the BACK and NEXT keys.

Press the EDIT button again to exit, or press the Power/Home key.

Quick Gain Trim

Adjust the channel's output level by ± 12 dB. This is a trim only, and is relative to the output gain set within the channel's preset. It is reset to 0dB when a new preset is recalled.

Output Menu Channel 1	
> Output Name:	Delayed Tops Left Stack
> Gain (Trim Only):	+10.9dB
> Output Preset:	1" with HF Shelf +3dB
> Limiter Threshold:	...

Pressing the channel's Mute will change the readout to red, as the main LED output meters may be reading pre-mute and so still register level.

Output Menu Channel 1	
> Output Name:	Delayed Tops Left Stack
> Gain (Trim Only):	+10.9dB MUTED
> Output Preset:	1" with HF Shelf +3dB
> Limiter Threshold:	...



Output Preset

If the selected channel is running a specific preset, its name will be displayed here. Output preset will show the name of the output settings that have been selected either as part of a system preset recall via the amplifier's front panel, or the individual output settings selected through the remote software. This is read only and for reference. If there is no name in the system preset, the display will show "Output X settings" as appropriate.

Output Menu Channel 1	
> Gain (Trim Only):	+10.9dB
> Output Preset: 1" with HF Shelf +3dB	
> Limiter Threshold: (Auto Time Constants)	+39dB read only
> Polarity	...

Limiter Threshold

The selected output channel's RMS limiter threshold is shown for reference only and cannot be adjusted from the front panel. If the limiter's attack and release times are set to be automatically adjusted (according to the channel's crossover high pass filter frequency – see page 74 for details), this will be also be detailed on the screen.

Output Menu Channel 1	
> Output Preset: 1" with HF Shelf +3dB	
> Limiter Threshold: (Auto Time Constants)	+39dB read only
> Polarity:	+VE

Output Polarity (Phase Reverse)

The selected channel's output polarity is shown for reference only and cannot be adjusted from the front panel.

Output Menu Channel 1	
> Limiter Threshold: (Auto Time Constants)	+39dB read only
> Polarity:	+VE read only

System Menu

Overview

As the majority of APA's audio features are designed to be set up and adjusted only by remote control, this makes the navigation of the amplifier's front panel interface much simpler. The main menu (that is, not an output channel menu or user metric display) consists of "unit-wide" adjustments and controls.

These are summarised below and then detailed in following sections.

MAIN MENU

RECALL SUB MENU

Recall Unit Memory

(choose and recall complete or partial unit memories)

UNIT SUB MENU

Unit Info

(check firmware version and system information)

IP Address Setup

(automatic or fixed/manual IP selection)

AudioCore Unit ID

(Comms ID for AudioCore)

Identify Unit

(flash LED meters to highlight a unit in a rack)

Mains RMS Current Limit

(set maximum current draw from mains input)

Default Audio

(set audio path back to analogue 4 x 1 way, full range, limiters at 44dB)

Default User Settings

(set unit-wide non-audio settings back to defaults)

SECURITY SUB MENU

Security Clearance

(enable security with password)

Toggle Security Lock

(change security level)

Recover Security

(forgotten password override)

UPDATES SUB MENU

USB Disk Tools

(sync presets ,firmware etc. using USB flash drive)

Firmware Picker

(update firmware from version on internal SD card)



Understanding Your APA

Memories, Presets and File Structures

Internal SD Card

Each APA is fitted with an internal 4GB microSD card. This card is NOT user swappable or accessible. Changing or modifying the card outside the amplifier may result in corruption of settings, or damage to speaker systems and the amplifier itself. Attempting to access the card will expose the user to potentially lethal voltages and will also invalidate the warranty.

It is, however, useful to understand the file structure used on the card as it is relevant to preparing USB Flash drives when copying presets to/from your amplifier, or upgrading firmware.

The SD card is partitioned with these four user accessible folders:

/firmware – firmware updates (.bin format should be in this folder before syncing)
 /presets – unit presets (.preset format should be in this folder to sync presets)
 /wav – wav file for emergency voice evac (single file title "evac.wav" in this folder)
 /logs – performance and error logs (for diagnostic use only)

USB Flash Drives: Firmware Upgrades and Presets/Memories

Your amplifier can use a USB flash drive to update firmware, upload or download presets, and upload evacuation messages. The front panel USB socket is a MICRO USB male socket. An adapter (supplied) is required to connect a USB flash drive. Should you lose the adapter, you will need a USB MICRO type 'A' plug to USB type 'A' socket.

Should this prove difficult to obtain, the more common USB MICRO type 'B' plug to USB type 'A' socket will work, but bear in mind this may not be compatible in future software releases.

Shown is a USB MICRO type 'B' plug to USB type 'A' socket:



The USB flash drive MUST be formatted as FAT32 (so not as NTFS) and whilst it will not matter if it contains other data, it must contain the folder structure as described above for the SD card, namely:

From the root folder:

/firmware
 /presets
 /wav
 /logs

The capacity of the drive must be at least 64MB.

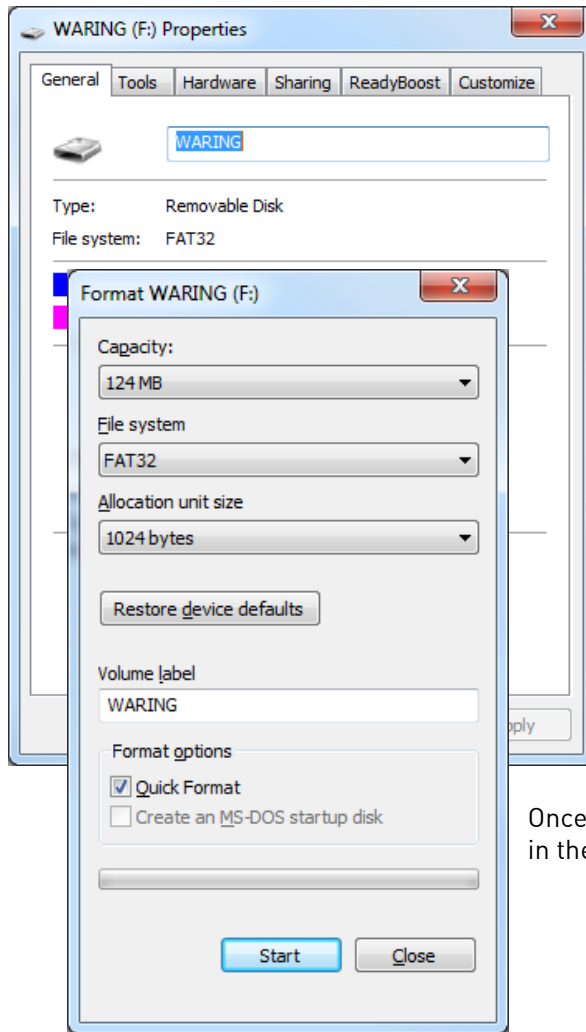

If you have a NTFS formatted drive instead and need to reformat it for FAT32, remember that you will lose all data stored on the drive.

Right click on it in your file manager and choose "format" and make sure "File System" is selected to "FAT32" as below.

Once this is complete, create the folder structure in the root folder as shown overleaf.

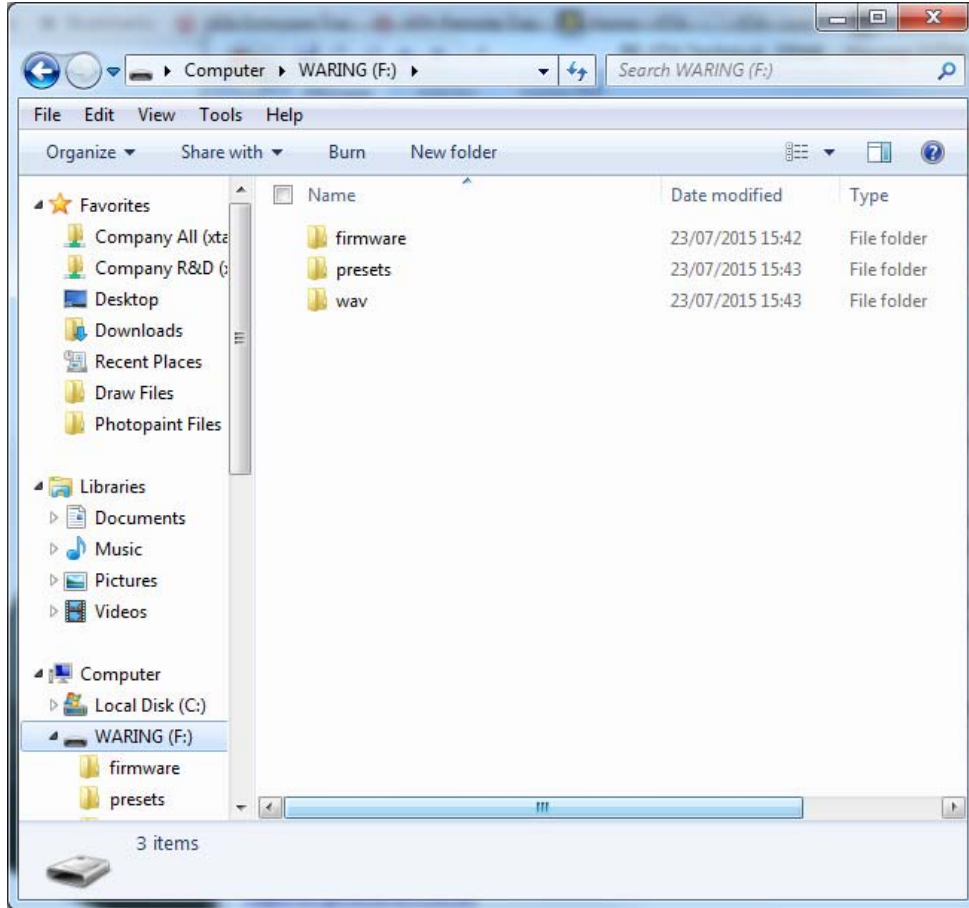

This drive is now suitable for copying and syncing firmware, presets and evacuation messages.

The Concept of File Syncing

Many users will already be familiar with the concept of file syncing, having used external hard drives for backing up important data on computers.

When a suitable USB drive is connected to your APA, the USB utility offers three options of how data is managed between the amplifier's internal SD card and the connected drive.

USB > SD: This will copy all files (of the correct format) that are in the /firmware, /presets and /wav folders into the same folders on the SD card in the amplifier. This direction is used for updating the amplifier firmware or uploading presets onto an amplifier.

SD > USB: This will do the opposite, and copy everything from the folders on the amplifier to the USB drive. This direction is used to backup firmware or presets that are currently in an amplifier, either for safe keeping, or to use them in another unit.

ALL: This will do both of the above – so anything not on the SD card will get copied **to** the amplifier, and anything not on the flash drive will get copied **from** the amplifier. Both folder sets will be identical after this procedure (with regards to correct file types – it will not copy unrecognized files across – jpgs, docs etc.).

Recalling Unit Memories

The memory structure in your APA is very flexible and allows different parts of the amplifier to be independently controlled via memory recalls without affecting other sections.

For example, it is possible to recall settings that just swap the inputs from analogue to AES, or one that just adjusts the input processing.

The sections of the working memory are split as in the diagram below:

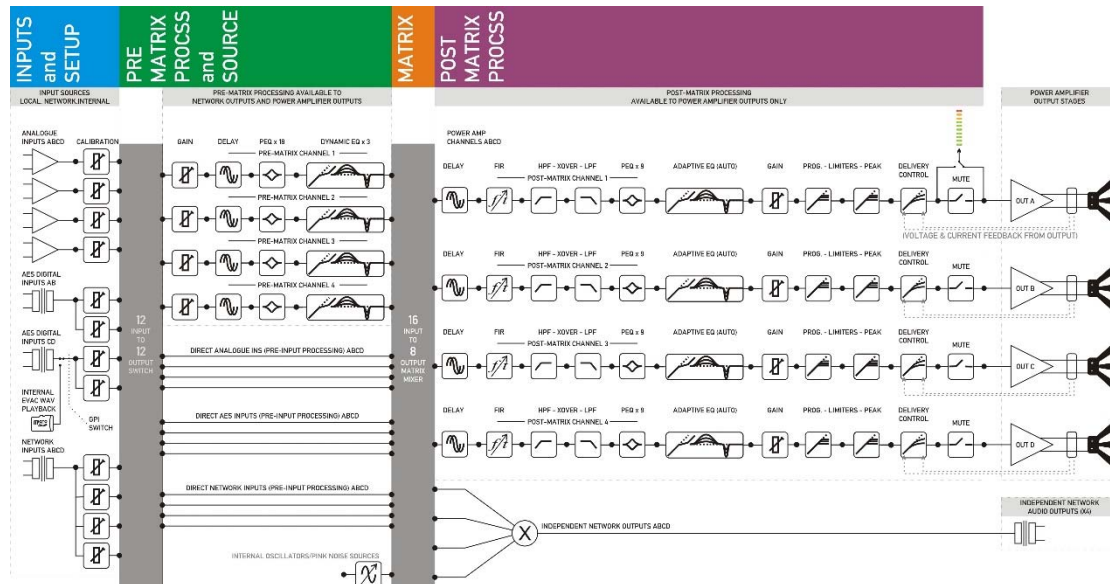

INPUTS and SETUP:

Analog or AES selection inc. calibration (latency and gain)

PRE MATRIX PROCESS and SOURCE:

All input pre-matrix processing (see page 24 for details) including sources for input channels

MATRIX:

Mix matrix settings for power amp processing and network outputs

POST MATRIX PROCESS:

All post-matrix processing for power amplifier outputs (see page 26)

Memories are built and stored via remote software packages, either using “APA Library Manager” (used to generate locked output *presets* which may also include SOURCE and INPUT settings) or “AmpControl” which can create complete *unit memories* that contain all sections. Please see our website for more information about obtaining these software applications.

Presets and user direct memories are loaded into the unit using the same procedure as for uploading new firmware to the internal microSD card in preparation for a firmware update. See the section on page 40 for more information on how this works.



To recall a unit memory, press MENU and then ENTER to jump to the RECALL SUB MENU:

Choose Unit Memory...	
> AES Selection A&B Only (INPUTS : --- : ----- : ----)	
> 2way LoHi+Subs 3&4 AES A (INPUTS : --- : MATRIX : POST)	
> House EQ + My System1 (INPUTS : PRE : MATRIX : POST)	
> 4 way with Subs on 1	...

Use BACK and NEXT to scroll through the available unit memories. The name of the memory is shown on the top line of each entry; with the second line summarizing what parts of the unit will be affected by a recall.

In the example above, the memory highlighted, "2 way LoHi+Subs 3&4 AES A", contains data about the input source (AES/Analogue selection, Routing Matrix data, and Output Processing data).

The memory *above* this, "AES Selection A&B Only" contains just data for the source selection – so it shows (INPUTS : --- : ----- : ----) on the lower line.

Press ENTER to choose this memory for recall – you will then see more detail and a confirmation screen:

Recall Unit Memory?
2way LoHi+Subs 3&4 AES A
This will affect the following sections: Source Selection Mix Matrix Output Processing
Press ENTER to proceed. MENU to cancel.

A final press of ENTER will recall the settings, with a confirmation message, before dropping back to the home screen.

Unit Memory Recalled!
Unit memory running is: 2way LoHi+Subs 3&4 AES A

This Amplifier is:	
SUBS FAR LEFT STAGE	
Unit memory running is: 2way LoHi+Subs 3&4 AES A	
Status: OK	Security level: 0 (Full Access)
IP:192.168.45.14	Unit ID: 01 35 45 F4 5B



Upgrading Firmware via Ethernet

IMPORTANT NOTE

From version 2.00 firmware onwards, we recommend using the Ethernet based firmware update method. Note that version 2.00 will replace remote communication via AmpControl with integration into AudioCore.

Presets created using AmpControl will be erased in your APA as part of the firmware upgrade.

Backing Up User Memories

Once you have made the physical connections between your PC and the amplifiers the instructions below assume you are starting from a blank work space in AudioCore:

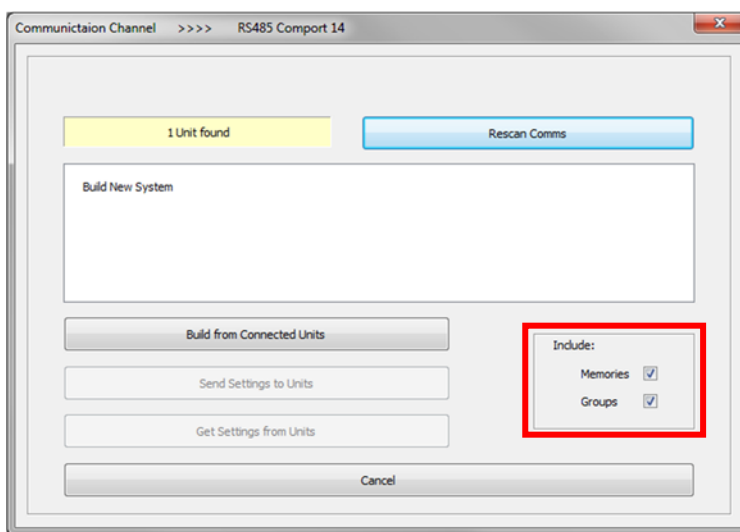

Pressing the Online button will display the Comms Control window, which shows the current connection type in the title bar and a variety of status and options.

As there are no pre-existing units in the workspace, the only option is to “Build System from Connected Units” — the yellow pane in the example shows that one has been discovered, you may see more units depending on how many you

have connected in your system

The status window shows that the Build New System is available.

Note the two tick boxes to include unit memories and group data in the upload which will start when the “Build System From Connected Units” button is pressed.

To back up the unit memories to your AudioCore file you must make sure the “Memories” tick box checked. If you have not used grouping before or are unsure, leave “Groups” unchecked.

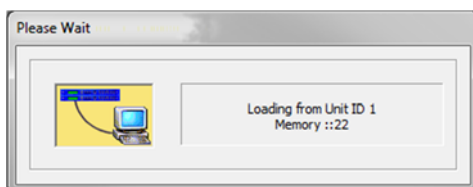

After pressing the “Build...” button a progress window will appear. The units will connect and the memories will be downloaded in Unit ID sequence. Make sure that each Unit ID appears in this window. Once complete it will close and the units will appear in the workspace.

At this point save the AudioCore file, as a back-up, to a convenient place on your PC. You can then click the ‘On Line’ button again to disconnect AudioCore and then close it down.

Upgrading Firmware

Loading new firmware uses the same "XTA_DeltaLoader" utility that is bundled with the firmware "bin" (binary) file. Firmware is amplifier model specific, please be very careful when selecting and uploading the firmware files. As part of the ZIP file download you should have all the firmware files required for each model (including DPA and MC² Delta DSP models).

Amplifier Communications Set-up

Disconnect or power down all other APA amplifiers on your network – the loader will warn if multiple amplifiers (including DPA and MC² Delta DSP models) still online.

Download the Files

Go to the Support > Firmware section of the XTA website to find the latest firmware images – these will be bundled with the "XTA_DeltaLoader" application that is used to connect and update your amplifier.

<https://www.audiocore.co.uk/support/firmware/>

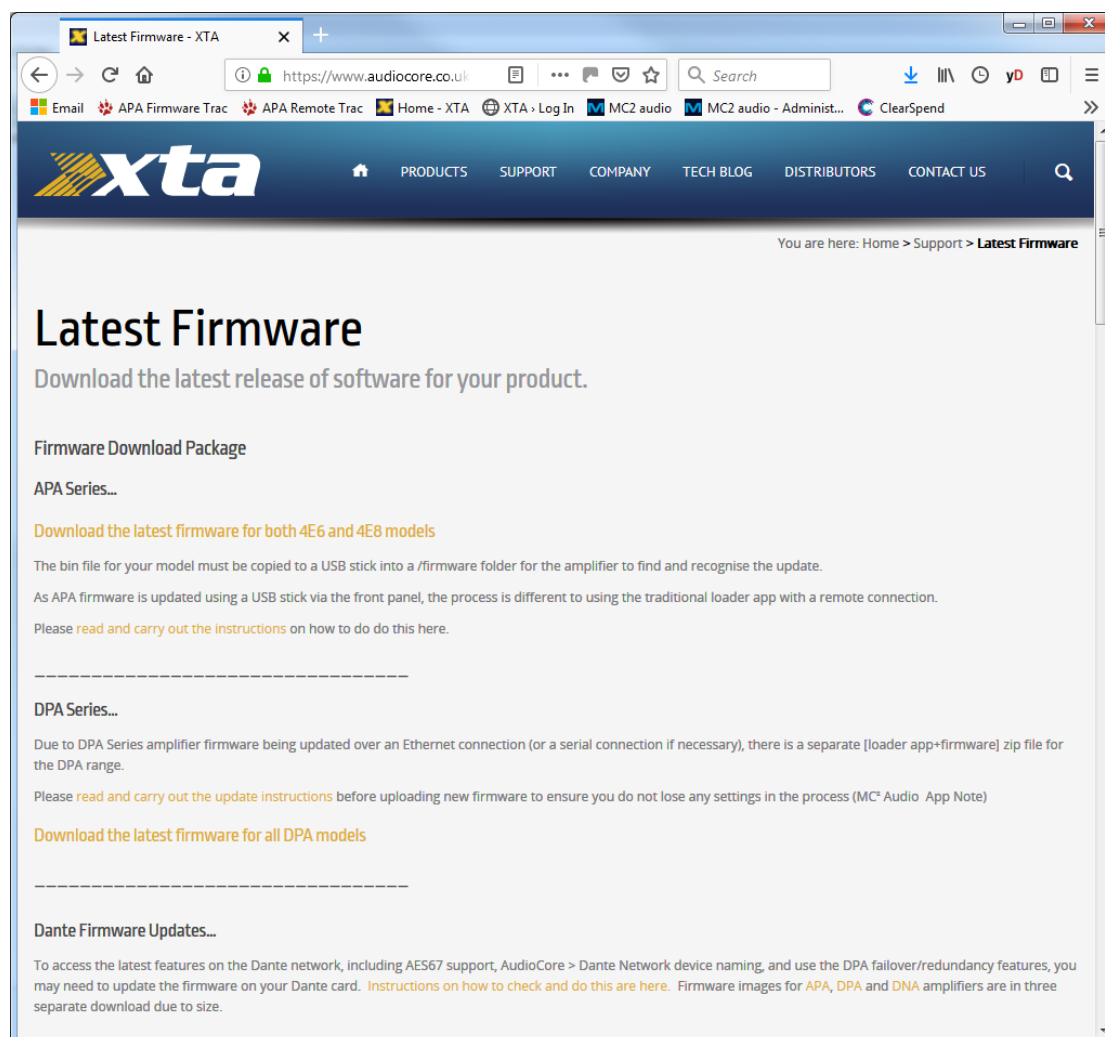

Latest Firmware - XTA

https://www.audiocore.co.uk

Search

Email APA Firmware Trac APA Remote Trac Home - XTA XTA - Log In MC2 audio MC2 audio - Administr... ClearSpend

xta

PRODUCTS SUPPORT COMPANY TECH BLOG DISTRIBUTORS CONTACT US

You are here: Home > Support > Latest Firmware

Latest Firmware

Download the latest release of software for your product.

Firmware Download Package

APA Series...

[Download the latest firmware for both 4E6 and 4E8 models](#)

The bin file for your model must be copied to a USB stick into a /firmware folder for the amplifier to find and recognise the update.

As APA firmware is updated using a USB stick via the front panel, the process is different to using the traditional loader app with a remote connection.

Please [read and carry out the instructions](#) on how to do this here.

DPA Series...

Due to DPA Series amplifier firmware being updated over an Ethernet connection (or a serial connection if necessary), there is a separate [loader app+firmware] zip file for the DPA range.

Please [read and carry out the update instructions](#) before uploading new firmware to ensure you do not lose any settings in the process (MC² Audio App Note)

[Download the latest firmware for all DPA models](#)

Dante Firmware Updates...

To access the latest features on the Dante network, including AES67 support, AudioCore > Dante Network device naming, and use the DPA failover/redundancy features, you may need to update the firmware on your Dante card. [Instructions on how to check and do this are here](#). Firmware images for APA, DPA and DNA amplifiers are in three separate download due to size.

Connect To The Amplifier

Start the XTA_DeltaLoader application:

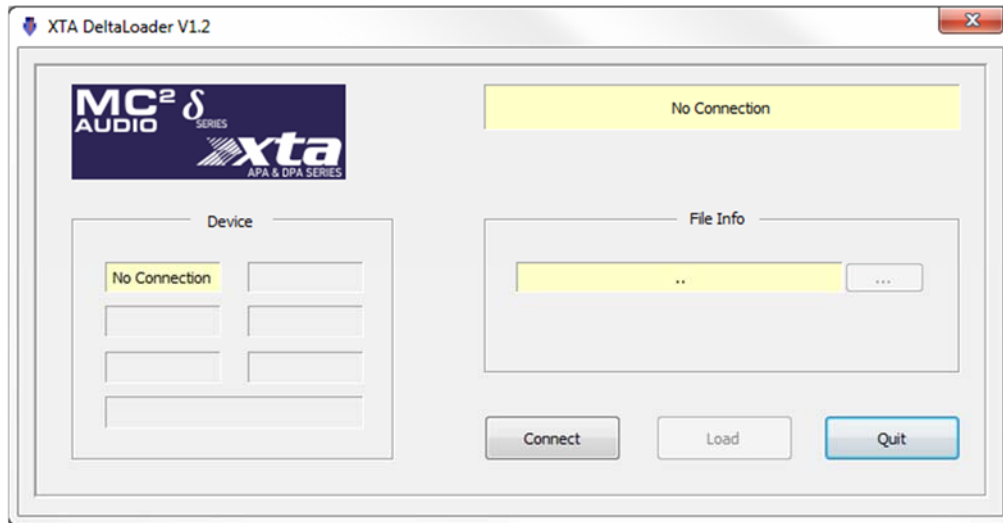

Click the "Connect" button, the software will scan all available connections and search for connected amplifiers.

Note:

Depending on your Windows Internet Security settings, you may see the window below the first time you open XTA_DeltaLoader and try and connect via an Ethernet connection. It is important that you accept all 3 tick boxes (as shown below) so that the software can access your network and discover the Delta or DPA amplifiers.

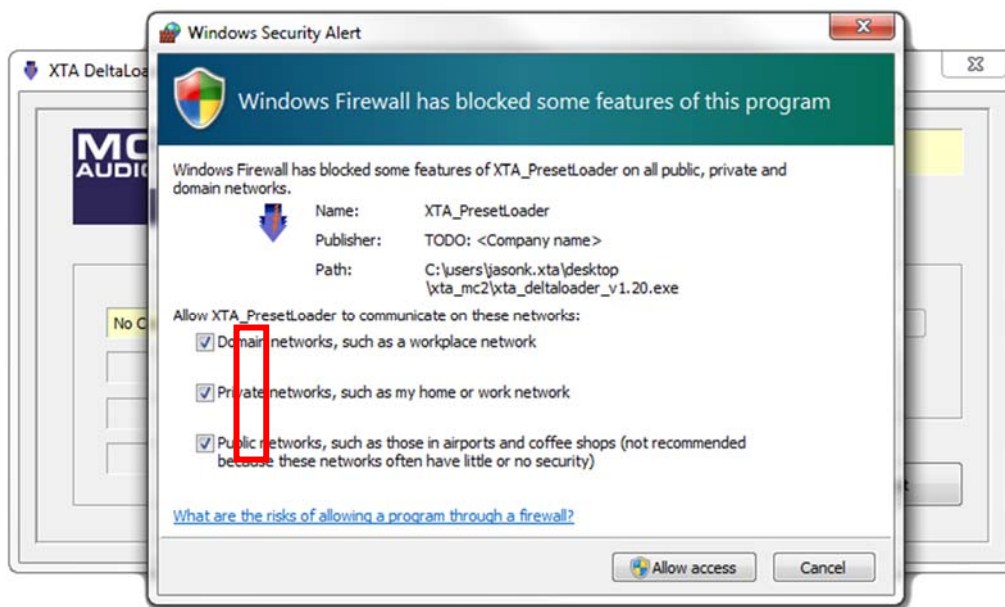

After a few seconds, the unit that you want to update should be located and its status and type should be displayed, along with the current firmware and some other information.



Choose What To Load

Click the button in the File Info section.

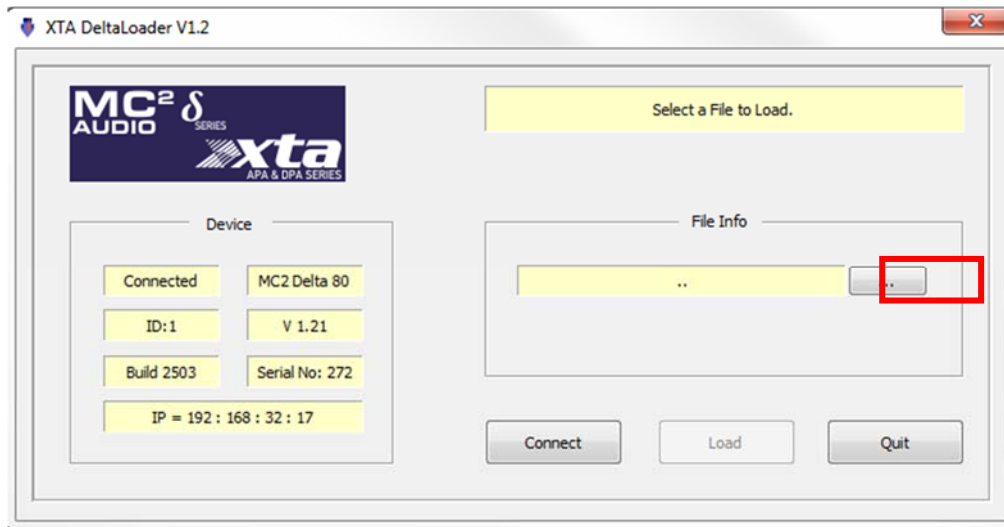

The file are no longer filtered by model, so please be careful and make sure you select the firmware .bin file that corresponds to the connected amplifier. Loading the incorrect firmware file could render the amplifier inoperable.

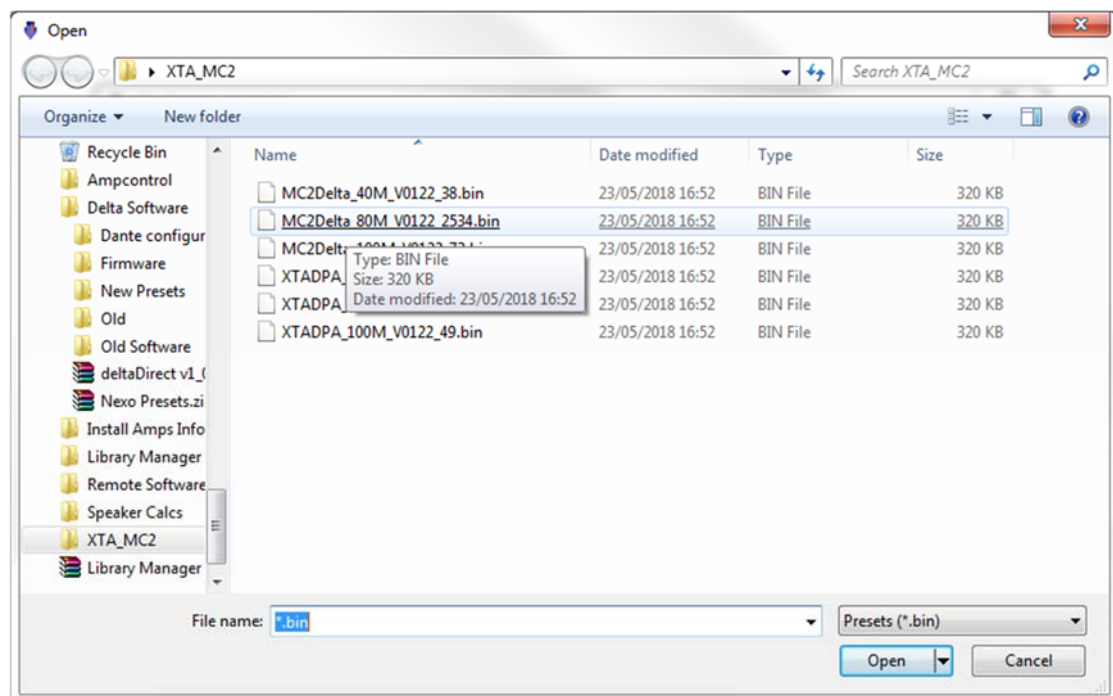

Start The Update!

Just before you press the "Load" button – please close any other applications running on the PC – interruptions in the process could render your amplifier inoperable. Do not disconnect the cable, turn off the power or attempt to close the loader app once loading has begun!

Now that you have been warned (!) – press the "Load" button. Confirm the load, and the amplifier will switch to Standby and begin to load the new firmware.

Upon completion, the app will close and your amplifier will restart.

Factory Reset (Please do NOT skip this step)

After the new firmware has been installed it is very important that a factory reset of the amplifier is performed. If you do not perform this step the DSP may perform erratically; this is essential.

Hold BACK and ENTER and then press MENU. Access the unit sub-menu – there will now be an extra reset option - Factory Reset – select this and confirm the reset.

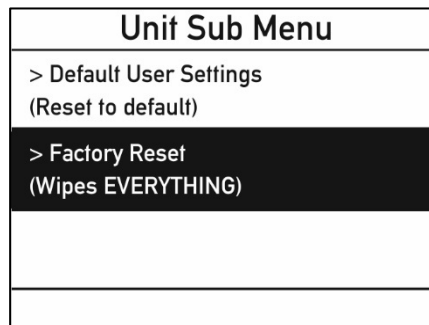

IMPORTANT: Remember to check the remote interface settings and unit ID's for each amplifier as these will have been reset to factory defaults as part of the reset process.

Re-installing User Memories

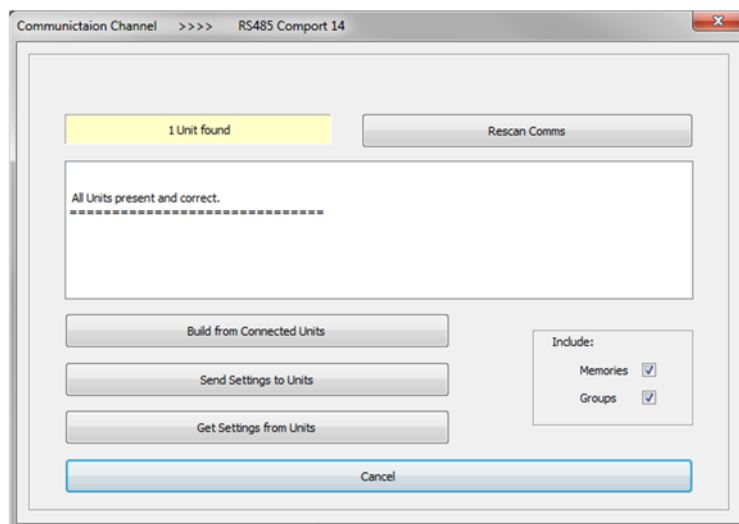

After checking the interface settings and Unit ID's you can now use the Audiocore file you saved earlier to upload the user memories back to your amplifiers.

Open Audiocore Amped Edition and load the file you saved earlier.

Check that you have the correct Comms mode selected in Audiocore.

As before click the 'On Line' button. Make sure that the

number of units found is the same as the number of units in the workspace.



Make sure that the 'Memories' tick box is checked and use the 'Send Settings to Units' button.

This will send all the User Memories and reinstall them in each Unit ID.

Finally, you should power cycle your unit to complete the changes.



Upgrading Firmware via USB

Upgrading firmware is a two stage process. The firmware file is first copied onto the /firmware folder on the micro SD card. The required version is then chosen via the front panel interface, and the upgrade initiated.

Your APA is capable of storing multiple versions of firmware on its internal micro SD card. We recommend, for "good housekeeping" not to keep multiple copies on your USB flash drive, at least not in the /firmware folder that the amplifier will look for. This will prevent incorrect or old firmware versions being accidentally copied to the amplifier.

The USB utility is available through the main menu but **ONLY IF THE AMPLIFIER IS IN STANDBY.**

To leave the screen and metering active in standby, *start with the amp in standby* and then hold the MENU button and briefly press Power/Home. Another press of Power/Home will clear this. (This mode is useful for checking presets or setting mains current limits before powering the amplifier up fully)

This is a safety feature so firmware updates and preset syncing cannot be enabled during a performance. Press MENU and find the UPDATES SUB MENU and press ENTER. Select the USB Disk Tools option, and press ENTER.

Main Menu	Updates Sub Menu
> SECURITY SUB MENU (locking front panel operations)	
> UPDATES SUB MENU (firmware and presets, USB sync)	> USB Disk Tools (sync data, browse etc.)
	> Firmware Picker (change unit firmware)

Remember, if the amplifier is still fully powered up, you will see this message:



Assuming the amplifier is in standby, it will now enable the USB port and try to detect any connected flash drive. This may take a few seconds so please be patient! Once detected, some details of the drive will be displayed and the options available will be shown:

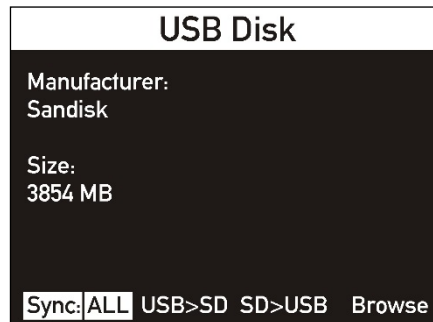

To copy the firmware from the USB stick onto the amplifier's SD card, use the encoder to highlight the USB>SD option, and press ENTER. Any files in the /firmware folder on the USB flash drive that are not already in the corresponding folder on the SD card (with the file extension ".bin") will be copied, and the progress will be shown:

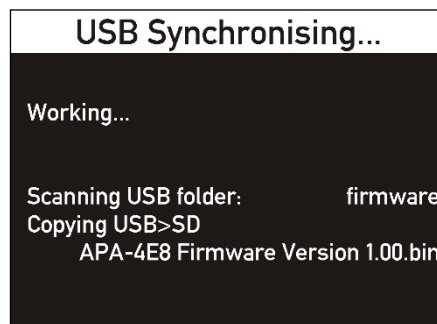

As mentioned earlier, it is good practice to ensure that only the latest firmware version exists in the USB /firmware folder, otherwise the SD card may eventually contain multiple copies of firmware.

Once finished, the display will show:

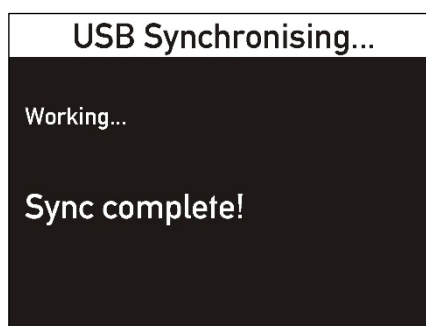

Now that the firmware has been copied to your APA's SD card, it can be used to finish upgrading the amplifier. Press MENU to drop back to the UPDATES SUB MENU and navigate to:

Updates Sub Menu
> USB Disk Tools (sync data, browse etc.)
> Firmware Picker (change unit firmware)

...and press ENTER. You will now see a list of all the firmware versions stored in the /firmware folder on the amplifier's SD card.

Firmware Picker
> Unit firmware APA-4E8 Version 1-00.bin
> Unit firmware APA-4E8 Version 1-04.bin
> Unit firmware APA-4E8 Version 1-07.bin

Use the BACK and NEXT keys to choose the latest version and press ENTER to start the process. The current settings will be backed up first, followed by an integrity check on the file, and then it will overwrite the current firmware with the new version.

Firmware progress
Firmware change progress:
Saving current state... done!
APA-4E8 Version 1-04.bin
Loading file from SD Card... done!
Verifying firmware image... success!
Reflashing, unit will reboot...
Please Wait

The amplifier will switch off for a few seconds and the POWER key LED will alternately flash green/red as the update progresses. When complete the amplifier will power up again if it was previously on, otherwise it will reboot to standby.

PLEASE DO NOT TURN OFF THE AMPLIFIER DURING THE UPDATE PROCEDURE.



Mains RMS Current Limiter

As your APA is capable of drawing huge amounts of current from the mains supply (in excess of the 32A long-term specified for the "PowerCon" mains connector), it has a programmable mains current limiter that can be used to prevent excessive current draw, especially when running on supplies with sensitive current breakers or on lower rated supplies (such as a 13A domestic UK supply).

Exceeding the current limiter threshold will begin to gradually pull in limiters (separate to those set by the user for speaker driver protection) to reduce the overall level. These limiters have very slow attack and release times so their effect is more like gentle gain control than dynamic limiting and so has a very benign effect on the audio.

It can be adjusted from the front panel by pressing MENU and navigating to the UNIT SUB MENU and pressing ENTER, then press NEXT to highlight the option:

Unit Sub Menu	
> Identify Unit (Highlight this amplifier)	
> Mains RMS Current Limit (To protect breakers)	25.7A
> Default Settings (Analogue 4 x 1 way)	

The current limit can be set to a minimum of 10.0A up to a maximum of 45.0A in 0.1A increments.

Evidence of this limiter becoming operational will be shown on the Incoming Mains Monitor User Metric. If the current draw of the amplifier begins to exceed the threshold the current meter will additionally display how much gain reduction is being automatically applied (only if below the speaker protection limiter thresholds) to stay operational and keep playing.

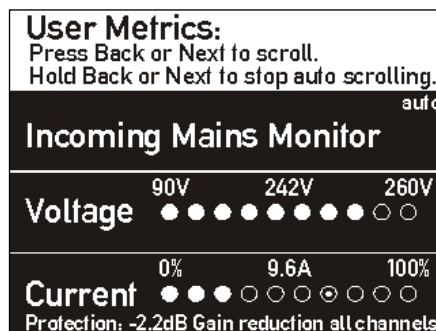

Identify Unit

To help pick out individual amplifiers in a larger system, a two way identification mechanism is built into your APA. This will flash the LED meters in a pattern when enabled, and also flag it in the remote software.

This can also be enabled remotely so allowing an amplifier to be highlighted from a distance.

Press MENU and navigate to the entry in the UNIT SUB MENU:

Unit Sub Menu	
> Unit Info (IP, Firmware Versions etc.)	
> Identify Unit (Highlight this amplifier)	
> Mains RMS Current Limit (To protect breakers)	
> Default Settings	...

Pressing ENTER will toggle the Identify feature off and on. It will persist even if the menu system is exited, but can be cancelled by pressing the Power/Home button briefly.

Default Audio

Your APA can be reset to a basic 4 in – 4 out configuration (fed from analogue inputs) and all user accessible features restored to defaults. Limiters will be set to maximum (so allowing full power output!) and all EQ and crossovers, delays and dynamics will be bypassed. Output mutes will be enabled.

Press MENU and navigate to the entry in the UNIT SUB MENU:

Unit Sub Menu	
> Mains RMS Current Limit (To protect breakers)	
> Default Audio (Analogue 4 by 4)	
> Default User Settings (Reset to default)	

Pressing ENTER will ask for confirmation – press ENTER again and the amplifier will immediately switch to standby. When next powered up the defaults will have been loaded. Note that this does NOT delete any user memories from the SD card or erase any settings. For details of how to perform a full factory reset, please contact XTA.



Default User Settings

Your APA's non-audio related settings can also be defaulted independently. These include the mains current, the IP address configuration, and anything else that can be adjusted in the UNIT SUB MENU (excluding the Identify function which can be cancelled by toggling it in the menu, or briefly pressing the Power/Home button

Press MENU and navigate to the entry in the UNIT SUB MENU:

Unit Sub Menu
> Default Audio (Analogue 4 by 4)
> Default User Settings (Reset to default)

Pressing ENTER will ask for confirmation – press ENTER again and the amplifier will restore the defaults with a “done!” message when complete. Note that this does NOT delete any user memories from the SD card or erase any settings. For details of how to perform a full factory reset, please contact XTA.

Emergency Voice Evacuation Playback

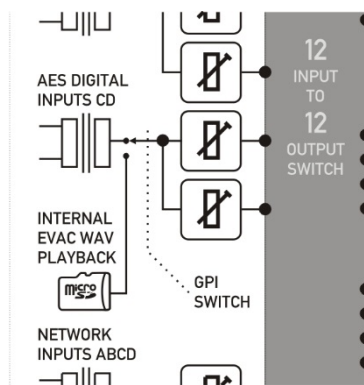

If a suitable file exists in the amplifier's /wav folder on the SD card, it will be played back on all outputs that have the route from AES C&D enabled. This input is interrupted by the evac playback message when GPI 1 is enabled.

The file format for correct playback is 16 bit stereo uncompressed wav file, with a sample rate of 44.1kHz.

When a logic "high" signal is presented on GPI 1, playback will commence and repeat indefinitely until the trigger signal is removed.

Playback level is adjusted by using the AES C&D level control in the remote software. It is not intended that this feature should be used if this AES input is integral to any installation or set-up.

Remember that the GPI inputs are isolated so the negative terminal of GPI 1 must also be connected to ground. A local 3v3 supply is present on pin 1 of the connector, and ground on pin 10 so for a non-isolated contact closure connection the wiring would be as below:

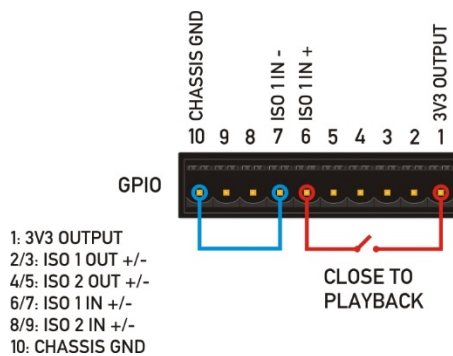

This feature will be expanded in future firmware releases.

System Security

Overview and Locking Procedure

Your APA has a sophisticated security system that consists of three hierarchical levels, which can be populated with any combination of controls to limit access to various parts of the system, both locally and remotely. This will be fully implemented remotely in a future release, but currently, the first level of security is pre-populated with a locking profile that locks out the front panel access to mutes, gain trims and the power button (still functions as the HOME button but cannot switch between standby and on if security is enabled). Unit memory recall is also disabled.

To enable security, press MENU and navigate to the Security Sub Menu and press ENTER.

Security Sub Menu	
> Security Clearance (Change security level)	0
> Toggle Security (Protect all controls)	0
> Recover Security	...

Press ENTER to change security clearance. Currently this is fixed at level 1, with a password of "one", so enter this using the rotary encoder to change characters and BACK and NEXT to scroll along the password. Press ENTER – if correctly entered, the amplifier will report success and then the security level can be changed to 1.

To do this, select the "Toggle Security" option and press ENTER to change to level 1.

Press Power/Home to go back to the home screen and the security level shown on the status line will change back to zero from one after a few seconds. Now, all controls should be locked. Some menu options will still be selectable but will not allow confirmation (such as memory recall, or default settings – the final stage of the process will be locked out).

Unlock using the same password ("one").

Forgotten Your Password?

Don't panic! Just navigate to the "Recover security" option in the SECURITY SUB MENU and press ENTER – you'll see the following with a "recovery challenge" code. Make a note of this and contact us for a new password.

Security Auth Required!	
This control is in security level:	42 (XTA)
You are currently at security level:	0 (zero)
Recovery challenge:	52b7d65
Enter password to gain authority:	–

Call us on +(0)1299 879977, or email tech@xta.co.uk for help.

The recovery challenge code is rolled over every time the amplifier is disconnected from the mains supply so please leave it plugged in (it can be left in standby) until you've had the code from us.

This procedure will not delete any user memories or settings stored on the SD card.



System Warnings

Your APA has a multitude of temperature sensors (over 20!) as well as real time high resolution voltage and current measurement converters (24 bit, 96k) to feed back information to the DSP in real time so the amplifier adapts its operation over time to stay playing as long as possible during any performance.

External conditions can influence how the amplifier behaves. For example, incoming mains voltage (especially if being fed from a generator), ambient air temperature, and air flow around the amplifier.

More obvious factors will also affect operation, such as connected load impedances, and audio input levels. The status bar on the home screen should normally show "OK" if nothing is causing your APA any stress.

This Amplifier is:	
SUBS FAR LEFT STAGE	
Unit memory running is: 21" Infrass + 18" LMX	
Status: OK	Security level: 0 (Full Access)
IP:192.168.45.14	Unit ID: 01 35 45 F4 5B

Should there be something that requires attention, or the amplifier has had to take preventative measures to carry on working, this will be shown on the status bar, in red.

The table overleaf explains these warnings and what you can do to restore full performance again if any appear.



Warning Message	Shutdown?	What to do...
Status: Mains Under Voltage	No, but close...	Input voltage below 90V – increase mains supply voltage – can you shorten the mains cable run at all?
Status: Mains Over Voltage	No, but close...	Disconnect from supply! Input voltage above 260V – decrease mains supply voltage!
Status: Mains Over Current	No, but close...	Reduce loads on outputs or input level or use the current limiter – see page 54 for how to do this.
Status: Amplifier Temperature High	No, but close...	Check loads and that vents aren't blocked and fans turning – will restart automatically when cooled.
Status: PSU Temperature High	No, but close...	Check loads and that vents aren't blocked and fans turning – will restart automatically when cooled.
Status: Mod Rail Safed	Yes, all outputs	Internal system warning – reset by a power cycle and contact XTA if continues to appear.
Status: HT Rails Low	Yes, all outputs	Internal system warning – reset by a power cycle and contact XTA if continues to appear.
Status: HT Rails High	Yes, all outputs	Internal system warning – reset by a power cycle and contact XTA if continues to appear.
Status: Mains V Low Safed	Yes, all outputs	Mains now too low for satisfactory operation. Increase mains voltage and amplifier will restart.
Status: Mains V High Safed	Yes, all outputs	Mains now too high for safe operation. Decrease mains voltage and amplifier will restart.
Status: Mains I High Safed	Yes, all outputs	Excessive current draw could cause permanent damage – reduce loads or increase mains voltage.
Status: Channels Safed PSU Temp	Yes, all outputs	Check loads especially at lower mains voltages – amplifier will restart when temperature reduces.
Status: PSU Safed PSU Temp	Yes, all outputs	Check loads especially at lower mains voltages – amplifier will restart when temperature reduces.
Status: Chan X Temp Safe	Only affected channel(s)	Check channel load has not changed or shorted. Disconnect one of parallel loads if necessary.
Status: Chan X OCM Safe	Only affected channel(s)	Excessive current draw could cause permanent damage – check loads have not changed.
Status: Chan X HF Safe	Only affected channel(s)	Excessive HF energy can damage output filters and devices. Check no oscillations at input.
Status: Chan X DC Safe	Only affected channel(s)	DC voltage – internal condition – contact XTA for more information. May clear with a reboot.

Remote Connection to your APA

Overview

Full remote control of all your APA's DSP functionality and monitoring of all aspects of its performance is achieved by connecting it to a standard Ethernet network.

There are three RJ45 ports on the rear panel of your APA – two are connected to the network audio interface card and one is designated as the “control” port “CTRL” which is independent of the network audio interface and is used as your remote control connection. By arranging the connections like this, your amplifier is future-proofed against changes in network audio protocols and topologies, should these change in years to come.

Ideally, your computer network infrastructure will include a DHCP server. The Dynamic Host Configuration Protocol server is responsible for assigning, amongst other things, IP addresses to connected clients. This server functionality may be implemented in your network router, or be running as an application on your network's server, if one exists. If you are unsure as to whether your network has a DHCP server, you should contact the administrator to find out. Many wireless routers and switches will have this built-in.

It is not essential for connection to a network of APA units, but it makes management of the network much simpler and more secure.

Connect to a Network

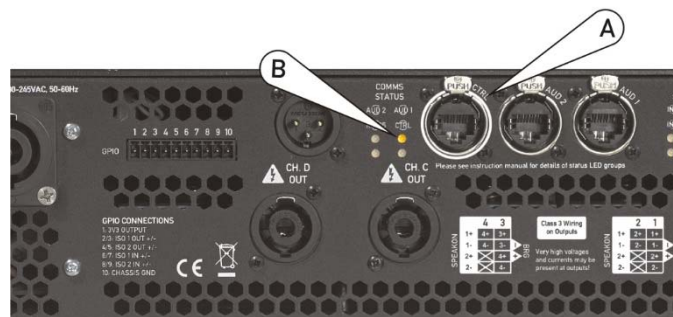

Plug a standard Ethernet cable into the “CTRL” port on the rear of your APA (A).

Connect the other end of this cable to your router/switch.

If a valid connection is established, the CTRL status LED on the rear panel will illuminate in yellow (B), and the front panel CTRL LED below the display will illuminate in green (C).



Assuming the home screen is visible (briefly press the POWER/Home button if not), after a few seconds the IP address shown at the bottom of the screen will change from 0.0.0.0 to a valid address, normally of the form 192.168.nnn.nnn.



This Amplifier is:	
SUBS FAR LEFT STAGE	
Preset running is: 21" Infrass + 18" LMX	
Status: OK	Security level: 0 (Full Access)
IP:192.168.45.14	Unit ID: 01 35 45 F4 5B

The unit should now be visible to the remote control software, as long as your computer is connected to the same network.

Adhoc Connections (no DHCP Server)

It is possible to connect directly to a single APA amplifier without routing through a network. This connection also uses the "CTRL" port on the rear panel, but does not require a DHCP Server to be preset to assign an IP address. A valid network connection must be established first for this process to begin – the CTRL LED must illuminate. Plug an Ethernet cable in as for the network connection, but plug the other end of the cable directly into your computer's Ethernet port. The amplifier will assign its own internally generated IP address after about 30 seconds, if no valid DHCP Server has replied.

This is indicated by the IP address that is shown changing from 0.0.0.0 to something of the form 169.254.99.4 – the leftmost pair of octets not being the normal "192.168" form. Note that these IP addresses are also dependent on how the network has been configured by your network administrator – these addresses are only given as examples.

Manual (fixed) IP Address Selection

There may be circumstances when auto generated IP addresses will not work within your current network infrastructure, such as in large systems where IP address ranges have been set by the network administrator. It is possible to manually set the IP address used by the unit.

Please note that the default setting is for IP addresses to be set automatically, and XTA recommend that this setting is used unless there is a valid reason not to!

To set the IP address manually, press MENU and navigate to the IP Address Set-up option in the UNIT SUB MENU and press ENTER.

Unit Sub Menu	
> Unit Info (IP, Firmware Versions etc.)	
> IP Address Set-up (Auto or fixed IP selection)	
> Identify Unit (Highlight this amplifier)	
> Mains RMS Current Limit	...

The default selection is for automatic IP address selection.

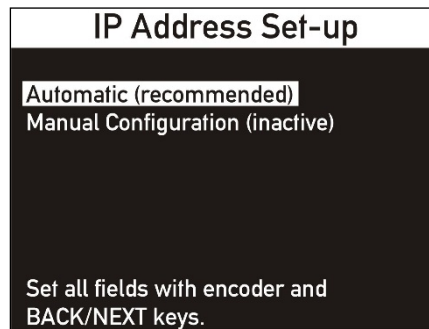

To change this to manual, press NEXT to display all the manual set-up parameters.

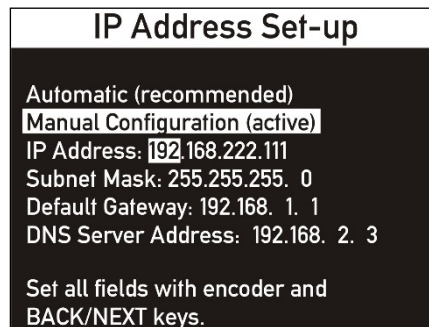

Changes are saved automatically – exit by either pressing MENU to drop back through the levels or power/home to get back to the home screen. Note that the manual IP address will not be shown on the home screen until a valid network connection is established (CTRL LED is illuminated).

Refer to your network administrator for the required settings of the other fields shown. Remember – if you don't need to set a manual IP address, return the unit to automatic mode by pressing the BACK button on this screen until "Automatic (recommended)" is highlighted again.

AudioCore ID Number

In addition to setting the IP address, when using multiple units on the same network, they must all be set to different AudioCore ID numbers. To set the IP address manually, press MENU and navigate to the IP Address Set-up option in the UNIT SUB MENU and press ENTER.

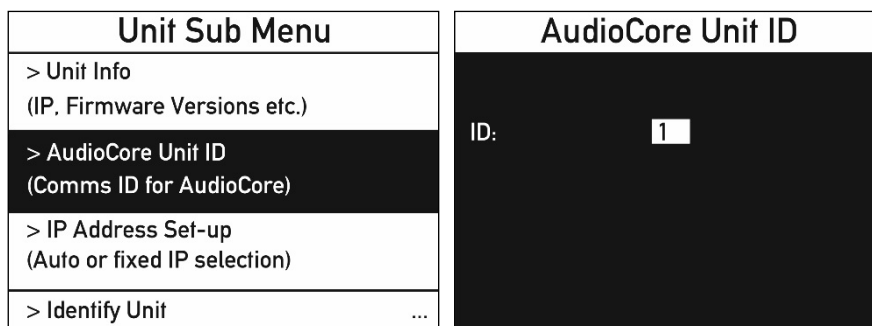

Set the ID number with the encoder and then either press MENU again to drop back a level or press Power/Home to return to the home screen.



Looking After your APA:

Maintenance

These maintenance instructions are for use by qualified personnel only. Before any routine maintenance, please ensure that your amplifier is disconnected from the mains supply!

The filter behind the air intake apertures on the front of your amplifier should be cleaned or replaced periodically, e.g. 12-24 months. Filters in amplifiers located in more 'dirty' atmospheres may require more frequent maintenance.

The filter should be 'dry' cleaned, using a vacuum cleaner preferably. Running the unit without a filter is not recommended unless it is within a 'clean room'. Replacement filter material is available.

If the fan vents on the rear of the amplifier develop a build-up of dust/debris around the holes, they can be cleaned with a dry paintbrush and a vacuum cleaner.

The casework of the amplifier may be cleaned with a lightly dampened cloth – do not use any solvents as they will damage the paint finish and could remove printing.

If you have any doubts about carrying out maintenance, please refer to a service engineer or contact your local dealer.

Warranty

Your APA is guaranteed for a period of five (5) years from the date of purchase. We hope that it gives you many more years of reliable service than this but, should anything go wrong, please contact us to advise you about repairs or any spares you might require.

Please do not attempt to repair it yourself, as doing so will invalidate the warranty.

Our contact details are:

XTA Electronics Ltd,
The Design House
Vale Business Park
Worcester Road
Stourport on Severn
Worcs
England
DY 13 9BZ

Tel: +44(0)1299 879977
Fax: +44(0)1299 879969

email: sales@xta.co.uk for general enquiries

Our website is a great place to get started if you have any questions regarding the general use of your unit or need copies of this manual in digital form, or datasheets and photographs. The datasheets also contain architect's and engineer's specifications.

www.xta.co.uk



Performance of your APA:

Technical Specifications

A note about how we measure performance.

Amplifier power ratings differ from manufacturer to manufacturer making it very difficult to compare models directly from spec sheets. We have tried to make the measurements presented as real world as possible for the application, which is music reproduction. Following these specifications, there is a section explaining the stimuli and conditions used to measure the amplifier - this enables you to subject other amplifiers to the same conditions to compare their performance - the *(Test type N)* you will see after all power specifications refers to these tests - see page 69.

General

Parameter	APA-4E8	APA-4E6
Amplifier Type	Class D amplifier with digital processing and control	
Power Supply Type	Universal input, power factor corrected switch mode	
Number of Processing Channels	4	
Number of Output Channels	2 or 4	
Output Channel Operating Modes	Quad half bridge driving loads from 2-16 Ohms Stereo full bridge driving loads from 4-32 Ohms	
Peak Usable Output Voltage per Half Bridge Channel	180V	135V
Peak Usable Output Voltage per Full Bridge Channel	360V	270V
Peak Usable Output Current per Channel	72A	54A
Maximum output power: All channels driven (all channels running pink noise with 12dB crest factor)		
8 Ohms	6800W (4 x 1700W)	3760W (4 x 940W)
4 Ohms	13200W (4 x 3300W)	7440W (4 x 1860W)
2.7 Ohms	20000W (4 x 5000W)	12000W (4 x 3000W)
2 Ohms	20000W (4 x 5000W)	13000W (4 x 3250W)
Maximum output power: Both bridged pairs driven (all channels running pink noise with 12dB crest factor)		
16 Ohms	6800W (2 x 3400W)	3760W (2 x 1880W)
8 Ohms	13200W (2 x 6600W)	7440W (2 x 3720W)
4 Ohms	20000W (2 x 10000W)	13000W (2 x 6500W)

Audio System

Parameter	APA-4E8	APA-4E6
Frequency Response at 2000W into 4 Ohms	20Hz = +0dB / -0.25dB, 20kHz = +0dB / -0.5dB	
System Latency	1.25mS (Analogue) 1.64mS/(AES 96k)	
Maximum Output Level into 4 Ohms	+44dBu	+41.5dBu
Nominal Output Impedance	0.05 Ohm (half bridge), 0.1 Ohm (bridge)	
Output Noise into 4 Ohms (un-weighted)	-62dBu (22-22kHz)	-63.5dBu (22-22kHz)
Output Dynamic Range into 4 Ohms (un-weighted)	105dB (22-22kHz)	105dB (22-22kHz)
Maximum Input Level	+22dBu	
Nominal Input Impedance	16k (balanced), 8k (un-balanced)	
Nominal Analogue Gain	+32dB	
Analogue Input Channel Noise (un-weighted)	-90dBu (22-22kHz)	
Analogue Input Dynamic Range (un-weighted)	112dBu (22-22kHz)	
Analogue Input CMR at 100Hz	-80dB	
THD + Noise at 1kHz, 10W into 4 Ohms	0.04% (22-22kHz)	
THD + Noise at 1kHz, 100W into 4 Ohms	0.04% (22-22kHz)	
THD + Noise at 1kHz, 500W into 4 Ohms	0.06% (22-22kHz)	
THD + Noise at 1kHz, 1000W into 4 Ohms	0.08% (22-22kHz)	
THD + Noise at 1kHz, 2000W into 4 Ohms	0.10% (22-22kHz)	



Digital Audio

Parameter	APA-4E8	APA-4E6
ADC and DAC Sample Rate	96kHz (oversampling type)	
ADC and DAC Resolution	24bit	
Accepted AES3 Sample Rates	44.1kHz, 48kHz, 96kHz, 192kHz	
AES3 Resolution	16 to 24bit	
DSP Sample Rate	96kHz	
DSP Resolution	32bit (floating point)	
Processing		
General	Delay, Polarity, Gain, Latency Compensation	
Dynamic EQ (4 x 3 Bands)	Cut/Boost Abv/Blw THD; PEQ/Shelf/Full Range	
IIR Equalisation (108 Bands)	PEQ, Shelf, VariQ, Notch, BP, Allpass, Phase	
FIR Filtering	Variable # of taps x 4 output channels	
Crossover Filtering (4 x 2)	From 6dB/Oct. To 48dB/Oct. But./Bes./L-R	
Compressor (4 x 1)	Soft knee, manual/auto T.C., ratio up to 16:1	
Speaker Protection Limiters (4 x 2)	Look-ahead program; zero overshoot peak	
Amplifier Protection Limiters	Peak current limiter: per channel (optimised)	
Mains Breaker Protection Limiter	Average mains current draw (user adjustable)	
System Pre-sets	Over 100	
System latency		
Analogue In to Speaker Out	1.25mS	
AES In to Speaker Out	1.64mS	

Storage & Losses

Parameter	APA-4E8	APA-4E6
Stored Charge	7.5 Coulomb	2.5 Columb
Energy Stored	2700 Joules	900 Joules
Sleep Mode Power	<1WRMS	
Idle Power	200WRMS	150W RMS
Power Losses (for low power music)	400WRMS	300W RMS
Power Losses (for very high power use)	800WRMS	600W RMS
Efficiency (load dependant)	70% - 80% typical	65% - 75% typical

Physical and Mechanical

Parameter	APA-4E8	APA-4E6
Input Connections Audio	4 x XLR (AES switched onto inputs A & C)	
Output Connections Audio	4 x NL4 "Speakon"	
Power Connector	1 x 32A "PowerCon"	
Recommended Circuit Breaker	C32	
GPI Connections	10 pin mini-Phoenix	
RS485 Connector	1 x XLR Male (legacy only)	
Ethernet Connections	1 x RJ45 (100Mbit) Control; 2 x RJ45 (1Gbit) Audio	
Front Panel USB	Micro USB Type 'B'	
Display	QVGA Full Colour TFT	
Metering	4 x 10 point tri-colour LED, multi-mode	
System start-up time (from cold/standby)	24/18 seconds	
Dimensions	88mm x 482mm x 498mm (2U)	
Dimensions (shipping)	620mm x 620mm x 210mm	
Weight	15.0kg	14.0kg
Weight (shipping)	18.0kg	17.0kg



Input Power

Parameter	APA-4E8	APA-4E6
Operating voltage range	90V – 240V ³	
230V AC		
MAX long term current (1 hour)	16.5ARMS	9.3ARMS
MAX long term power (1 hour)	3800W RMS	2140W RMS
MAX short term current (2 sec)	24.3A RMS	13.5A RMS
MAX short term power (2 sec)	5600W RMS	3150W RMS
115V AC		
MAX long term current (1 hour)	29.6A RMS	18.0A RMS
MAX long term power (1 hour)	3400W ⁴ RMS	2070W RMS
MAX short term current (2 sec)	43.5A RMS	24.5A RMS
MAX short term power (2 sec)	5000W ² RMS	2820W RMS

Output Power: Peak Performance

Parameter	APA-4E8	APA-4E6
All channels driven Maximum output power (all channels running pink noise with 12dB crest factor)		
8 Ohms	6800W (4 x 1700W)	3760W (4 x 940W)
4 Ohms	13200W (4 x 3300W)	7440W (4 x 1860W)
2.7 Ohms	20000W (4 x 5000W)	12000W (4 x 3000W)
2 Ohms	20000W (4 x 5000W)	13000W (4 x 3250W)
Both bridged pairs driven Maximum output power (all channels running pink noise with 12dB crest factor)		
16 Ohms	6800W (2 x 3400W)	3760W (4 x 940W)
8 Ohms	13200W (2 x 6600W)	7440W (4 x 1860W)
4 Ohms	14800W (2 x 7400W)	12000W (4 x 3000W)
All channels driven 25mS 80Hz sine wave power burst at 150BPM with 10dB crest factor with all channels run simultaneously (over an hour assuming 20 degree ambient) (Test type 3)		
8 Ohms	6000W (4 x 1500W)	3400W (4 x 850W)
4 Ohms	10000W (4 x 2500W)	5600W (4 x 1400W)
2.7 Ohms	12000W (4 x 3000W)	6600W (4 x 1650W)
2 Ohms	12000W (4 x 3000W)	5600W (4 x 1400W)
Both bridged pairs driven 25mS 80Hz sine wave power burst at 150BPM with 10dB crest factor with all channels run simultaneously (over an hour assuming 20 degree ambient) (Test type 3)		
16 Ohms	6000W (2 x 3000W)	3400W (4 x 850W)
8 Ohms	10000W (2 x 5000W)	5600W (4 x 1400W)
4 Ohms	12000W (2 x 6000W)	6600W (4 x 1650W)
Single channel driven RMS sine wave long power burst with 9dB crest factor (2 seconds on, 12 off) (Test type 4)		
8 Ohms	1800W	950W
4 Ohms	3200W	1800W
2.7 Ohms	3600W	2000W
2 Ohms	3600W	2000W
Single bridged pair driven RMS sine wave long power burst with 9dB crest factor (2 seconds on, 12 off) (Test type 4)		
16 Ohms	3600W	1900W
8 Ohms	3600W	2000W
4 Ohms	3600W	2000W

³ Low mains voltages may result in reduced power output due to over current protection

⁴ Power de-rating indicated for mains operating at 115V



Output Power: Continuous Performance

Parameter	APA-4E8	APA-4E6
All channels driven (230V) RMS sine wave long term continuous power with all channels run simultaneously (over an hour assuming 20 degree ambient) <i>(Test type 1)</i>		
8 Ohms	3000W (4 X 750W)	1500W (4 X 375W)
4 Ohms	3000W (4 X 750W)	1500W (4 X 375W)
2.7 Ohms	3000W (4 x 750W)	1500W (4 X 375W)
2 Ohms	3000W (4 x 750W)	1500W (4 X 375W)
Both bridged pairs driven (230V) RMS sine wave long term continuous power with all channels run simultaneously (over an hour assuming 20 degree ambient) <i>(Test type 1)</i>		
16 Ohms	3000W (2 x 1500W)	1500W (4 X 375W)
8 Ohms	3000W (2 x 1500W)	1500W (4 X 375W)
4 Ohms	3000W (2 x 1500W)	1500W (4 X 375W)
All channels driven (115V) RMS sine wave long term continuous power with all channels run simultaneously (over an hour assuming 20 degree ambient) <i>(Test type 1)</i>		
8 Ohms	2400W ⁵	1300W
4 Ohms	2400W ³	1300W
2.7 Ohms	2400W ³	1300W
2 Ohms	2400W ³	1300W
Both bridged pairs driven (115V) RMS sine wave long term continuous power with all channels run simultaneously (over an hour assuming 20 degree ambient) <i>(Test type 1)</i>		
16 Ohms	2400W ³	1300W
8 Ohms	2400W ³	1300W
4 Ohms	2400W ³	1300W
Single channel driven RMS sine wave medium term continuous power per single channel (over 60 seconds assuming 20 degree ambient) <i>(Test type 1)</i>		
8 Ohms	1800W	950W
4 Ohms	3000W	1200W
2 Ohms	2000W	1000W
Single channel driven RMS sine wave long term continuous power per single channel (over an hour assuming 20 degree ambient) <i>(Test type 1)</i>		
8 Ohms	1000W	850W
4 Ohms	1000W	850W
2 Ohms	1000W	600W
Single bridged pair driven RMS sine wave long term continuous power per bridged pair (over an hour assuming 20 degree ambient) <i>(Test type 1)</i>		
16 Ohms	2000W	1200W
8 Ohms	2000W	1200W
4 Ohms	2000W	1200W
All channels driven Long term continuous pink noise with 12dB crest factor and all channels run simultaneously (over an hour assuming 20 degree ambient) <i>(Test type 2)</i>		
8 Ohms	6800W	3760W
4 Ohms	13200W	7440W
2.7 Ohms	20000W	12000W
2 Ohms	20000W	13000W
Both bridged pairs driven Long term continuous pink noise with 12dB crest factor and all channels run simultaneously (over an hour assuming 20 degree ambient) <i>(Test type 2)</i>		
16 Ohms	6800W	3760W
8 Ohms	13200W	7440W
4 Ohms	20000W	12000W

⁵ Power de-rating indicated for mains operating at 115V

Power Measurement Test Types

Test type 1: Continuous RMS Sine Wave

Electronic engineers usually find it easy to measure with constant sine wave tones, so we provide power figures in a continuous RMS sine wave format so that measurements can be made and understood in that context. In reality typical music programme is much more transient in nature, with large peaks and gaps in the sound and it has been generally accepted for many years that the peak power of music is 8 times higher than the average RMS power. However the modern trend towards heavily compressed or synthesised music in dance environments means that continuous sine wave tests once again have some relevance showing the sustained power capability of an amplifier's power supply and output channels. Tests are not limited to, but usually performed at 1kHz.

Test type 2: Continuous Pink Noise

The relationship between peak and RMS equates to a crest factor of 4 (or 12dB), which is commonly available in the form of pink noise which also conveniently provides a broad spread frequency spectrum. Power ratings using pink noise are also relatively easy to make and reasonably representative of real music, so we provide power figures in this format.

Test type 3: Short Burst Sine Wave

Some of the most taxing program material for an amplifier is electronic dance music. This is often dominated in the lower frequency spectrum by bass drum beats which concentrate all the high power energy into repeated large power pulses. These typically consist of one or two cycles of low frequency energy around 80Hz followed by decay and then a string of ongoing repeats, or beats.

To simulate this we have chosen to measure using burst waveforms with 2 cycles of 80Hz sine wave at full power and 30 cycles of 80Hz sine wave at a lower power (0.1466 of the burst power). This produces an average power that is $1/5^{\text{th}}$ of the burst power and equates to a crest factor of 3.16 (or 10dB) but with all the high power energy concentrated into the large pulses which are 25mS long and repeated at 150bpm. This pulsed power distribution is much more taxing on an amplifier than the more even distribution found in pink noise. Test can also be run at other frequencies providing their period is a multiple of 25mS.

Test type 4: Long Burst Sine Wave

Synthesised music often contains very high levels of low frequency, low crest factor energy in the form of complex waveforms that can last for several seconds. To test this we use a repeated burst format with full power sine wave applied for 2 seconds, and a 10 second rest state set at a lower power (0.1 of the burst power). This produces an average power that is $1/4^{\text{th}}$ of the full power; equating to a crest factor of 2.83 or (or 9dB), which is extremely demanding on an amplifier and the AC mains supply. Typically the AC mains and safety breakers will only be capable of supplying enough current for a single channel or bridged pair to be driven in this way so it is assumed that the other channels of the amplifier will run with much lighter loads reproducing the other areas of the frequency spectrum. For simplicity, this additional power is not simulated in the test. Tests are not limited to, but usually performed at 1kHz.



Additional Information About Your APA:

Appendix I: Dynamic EQ

Dynamic EQ is essentially a compressor or expander that can be set to respond and act upon only a certain range of frequencies. Its behaviour is dependent on the operating mode chosen: the operating modes are explained in detail below.

Mode I: "Cut Above"

Having selected the frequency band to work with, the dynamic eq will listen to this band and act upon it by cutting (compressing) any frequencies present in it that go above the predetermined threshold. Consider the example below where the threshold is set to -20dB , and the selected frequency band is centred around 1kHz , with a 'Q' of 1.0.

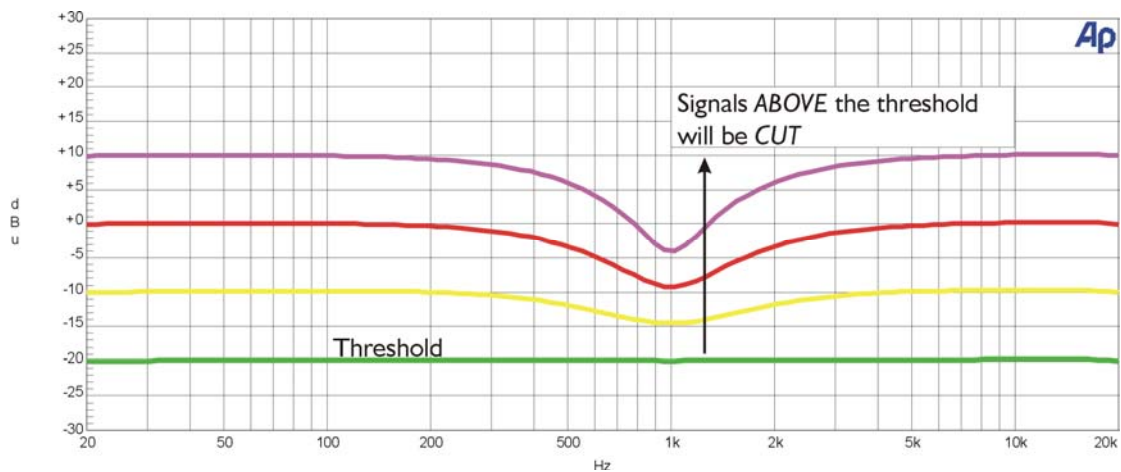

Signals below the threshold will pass unaltered, but as increasing signal is applied, those frequencies centred around 1kHz will be cut or compressed. The ratio in the above example is set at 2:1 so, as with any compressor, the amount of gain reduction applied depends on how much the signal exceeds the threshold. The red line represents a signal at 0dB , which is 20dB above the threshold. At 1kHz , therefore, the signal has been compressed to -10dB or 2:1.

Uses of "Cut Above" mode

Traditional use of 'frequency conscious' compression is to control or 'tame' a certain band of frequencies within the program material. Insertion of EQ into the sidechain will make the compressor respond to the required band, but it will cause broadband compression of the signal, so any peaks will cause the entire signal to be compressed. This produces the familiar problem of dulling the material if it is bass-heavy, or causing unnecessary dips and changes in ambience when attempting to remove sibilance. The difference with dynamic EQ is that only the band selected is compressed. This means that it becomes possible to compress the low frequency content of material without affecting the high frequencies at all. The result is increased volume and perceived level without sacrificing clarity. Any instance where the desired result is to control a band of frequencies, such as de-essing, or de-popping, without affecting the surrounding frequency ranges is an ideal use for this mode. Controlling LF spill and bleed in situations where it's desirable to maintain perceived level without causing environmental noise issues can also be achieved with use of a dynamic LF shelf in "cut above" mode with long attack and release times, Try de-essing with the filter centred at $8\text{-}9\text{kHz}$, and a relatively narrow 'Q' of about 4, attack 1mS , release 100mS .

Mode II: "Cut Below"

Having selected the frequency band to work with, the dynamic eq will listen to this band and act upon it by cutting any frequencies present in it that drop below the predetermined threshold. Consider the example below where the threshold is set to +10dB, and the selected frequency band is centred around 1kHz, with a 'Q' of 1.0.

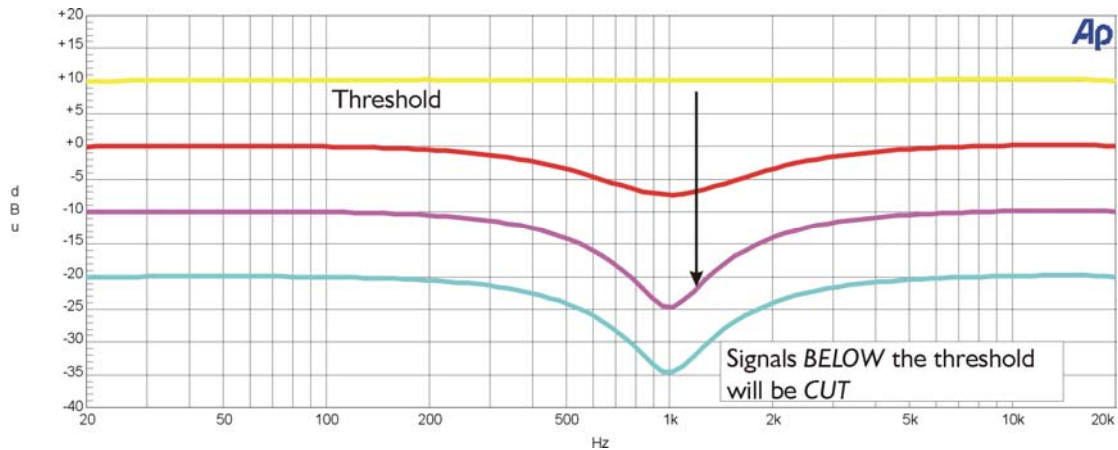

Signals above the threshold will pass flat, but as the level decreases, those frequencies centred around 1kHz will be cut or expanded. The amount of gain reduction applied depends on how much the signal drops the threshold and the ratio set – a 2:1 ratio would mean that for every drop of 1dB below the threshold, the band centred around 1kHz would drop by 2dB.

Uses of "Cut Below" mode.

Reducing the level of high frequency noise can be effectively implemented in this mode. Particularly effective on percussive material, unwanted tape noise and interference can be usefully removed without affecting the signal at normal levels.

Try the filter set to a high shelf mode at 4kHz, attack 25mS, release 100mS. The threshold setting is more crucial in this mode than usual, with the trade-off being effective removal of noise against possible intrusive dulling of the program material.



Mode III: "Boost Above"

This is the other less than traditional mode of operation, offering upward expansion, where the signal is boosted once it reaches the threshold. The example below shows that 1kHz filter again, this time with the threshold at -20dB. As can be seen, as the signal rises above the threshold it is progressively boosted around the 1kHz region.

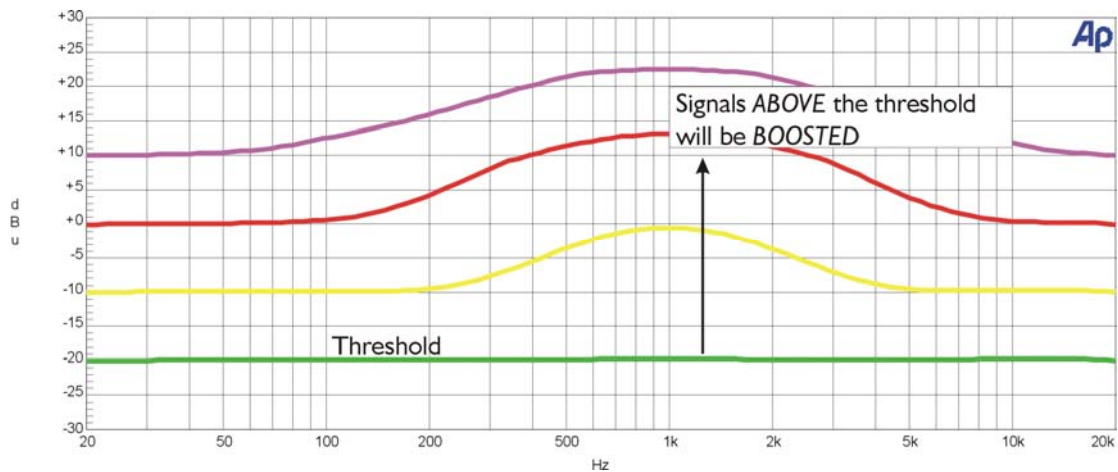

Uses of "Boost Above" mode.

This mode is more useful than it might first appear – the ability to add EQ only at higher signal levels allows some very effective emphasis of certain parts of the spectrum to be added, without the side effect of a permanent audible peak.

Adding some 'top end sparkle' – try picking out high-hats and cymbals with a filter at 12kHz, 'Q' of 1 Octave, and fast attack and release, typically 5mS and 25mS. This gives a significant boost to the top end, without bringing up noise in the absence of any high frequency content.

Similarly, 'punch' can be re-introduced to a lacklustre bass drum by setting the filter to about 80Hz and slowing the attack to 49mS and the release to 100mS. As the bass drum causes the EQ only to be applied on peaks, there is no additional muddiness added to the bottom end of the spectrum.

Mode IV: "Boost Below"

This mode operates in a slightly unconventional manner insofar as behaving as an 'upwards expander', as opposed to the more traditional 'downwards expander'. What this means is that as the signal drops below the threshold, the selected band of frequencies will be progressively boosted in relation to the rest of the spectrum, offering a perceived 'lift' in the band. Consider the example below where the threshold is set to +10dB, and the selected frequency band is centred around 1kHz, with a 'Q' of 1.0.

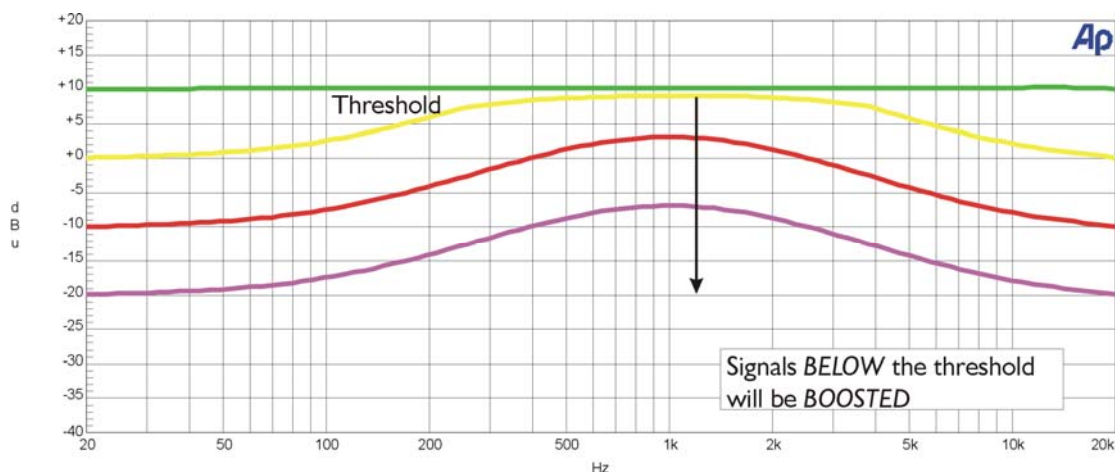

Signals above the threshold pass unaltered but, as the signal drops below the threshold, frequencies around the 1kHz region will be progressively boosted (or expanded). How much boost is applied will depend on the ratio set and how far below the threshold the signal actually is.

Uses of "Boost Below" mode

One of the best uses of this mode is in the area of voice levelling and clarification. Placing the filter at about 700Hz (lower to nearer 600Hz for men, up to 800Hz for women/children) with a wide 'Q' – typically 0.7, a ratio of 2:1, a maximum gain of 12dB, attack 10mS and release 100mS. This will ensure that quiet talkers will have their vocal range boosted, without bringing up system noise or microphone handling noise/room rumble.

Try experimenting with "auto-loudness" which compensates for the extremes of LF and HF roll-off at lower listening levels. Use two bands per channel as low and high shelving filters with a slow response envelope (over 1000mS or more on release), with a maximum gain of 9dB. Set the low shelf at about 100Hz or slightly lower, and the high shelf at about 8kHz to 10 kHz – basically like "bass" and "treble" controls. Set the ratio to 2:1 and the threshold such that the system is flat at louder (later evening) levels, but at reduced output, the LF and HF are both gently boosted to improve perceived fullness.

Appendix II: Program Limiter and Peak Limiter

Your amplifier has two levels of dynamic protection on its outputs – a traditional program limiter, and a peak limiter.

Program Limiter

High performance digital limiters are provided for each output with control over attack time, release time and threshold parameters. This level of control allows the user to balance the required subjective quality of the limiter against the driver protection requirements. It does also mean that an incorrectly set limiter may sound awful! In particular, as with all limiters, using too fast an attack or release time will result in excessive low frequency distortion. There is provision, within the remote software application, to set automatic limiter time constants. Use this option if you are unsure how to set the time constants manually. XTA recommend the use of the automatic setting.

In this mode the time constants will be automatically set from the corresponding channel's High-Pass filter frequency according to the table below.

High Pass Filter	Auto Attack Time	Release Time
<10Hz – 31Hz	45mS	x16 (720mS)
31Hz – 63Hz	16mS	x16 (256mS)
63Hz – 125Hz	8mS	x16 (128mS)
125Hz – 250Hz	4mS	x16 (64mS)
250Hz – 500Hz	2mS	x16 (32mS)
500Hz - 1kHz	1mS	x16 (16mS)
1kHz – 2kHz	0.5mS	x16 (8mS)
2kHz – >32kHz	0.3mS	x16 (4mS)

Peak Limiter

The main limitation with traditional dynamics control is the inability of the processing to react truly instantaneously to the signal. One of the most significant advantages of digital signal processing over analogue is the ability to delay the audio signal precisely and without extensive complex hardware. The entire domain of digital signal processing is based around the combination of delaying, multiplying, and accumulating numbers (representing samples of audio) to implement all the filters and dynamics processing we have come to expect today.

In the case of dynamics processing, being able to delay a signal allows the processor module to delay the main signal in relation to the sidechain (the signal being monitored relative to the threshold), so that it can compensate for peaks prior to the arrival of the main signal.

Consider the situation of a monitor engineer listening to a band perform. Having no access to dynamics processors, he has had to resort to manually 'riding the faders' in an attempt to keep control of the levels. Should the level of one of the channels on his desk reach an unacceptably high level, he will turn it down appropriately.

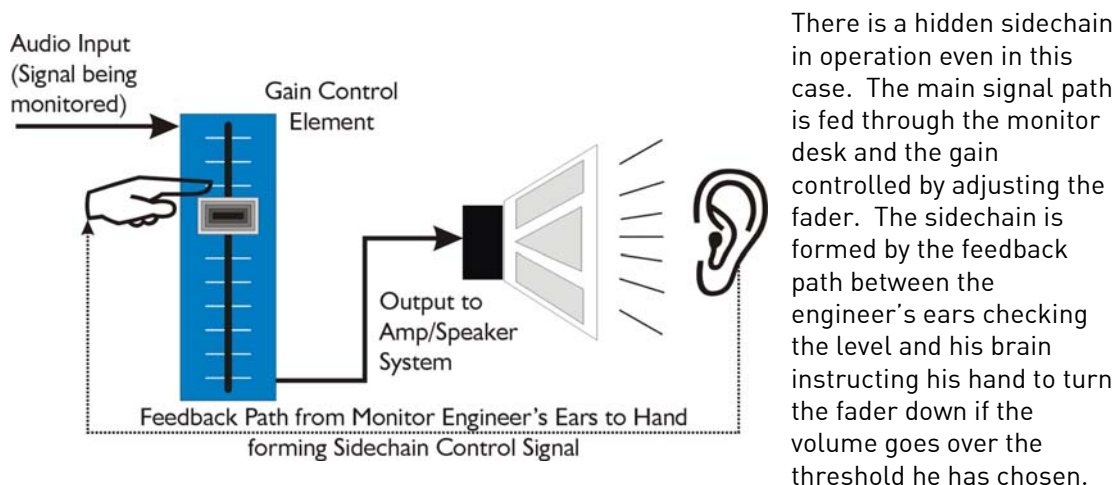

In this case, the delay between the signal actually going over the threshold, the engineer registering the situation, and then turning the signal down will be in the order of several hundred milliseconds at best. This will only be true if he is not distracted – in reality, it may be several seconds before any gain reduction is imposed on the signal to bring it under control.

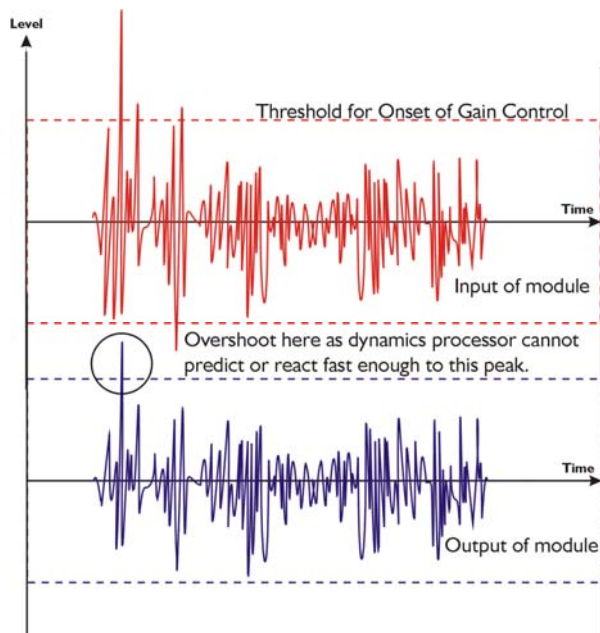

For an analogue dynamics processor, the situation is much better. Controlling the gain electronically, and not relying on a human sidechain feedback mechanism, it can react much more quickly.

The red waveform represents the input to the dynamics module, with the dotted line showing the threshold for gain control to occur. There are several peaks towards the start of this signal that are above the threshold, and so the dynamics processing should react to these as appropriate. (In this case reduce the gain).

The blue waveform shows the output of the dynamics module. The circled peak demonstrates that the processor has missed the first peak above the threshold

(as it is very fast and short), but has 'caught up' shortly afterwards, keeping all other peaks under control. As it is unable to predict what is coming, this will always be a failing with analogue dynamics processing.

The APA peak limiter pre-delays the sidechain signal, resulting in a "zero overshoot" limiter, which is able to catch all peaks and provide a reliable absolute maximum setting for the output of any channel.

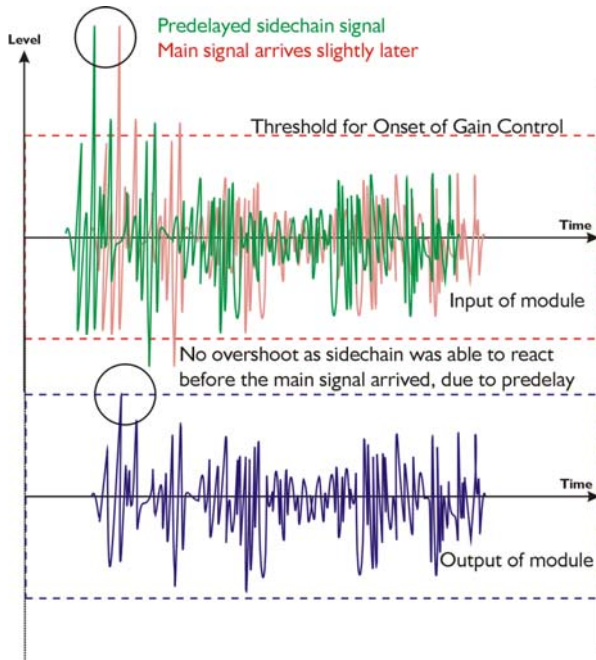

The pre-delayed sidechain is shown in green, with the main signal in red. As the main signal arrives slightly after the sidechain, the output from the unit does not suffer from the overshoot problem.

Remember that this delay is only in the order of tens of microseconds, and is a **pre-delay** – the sidechain is moved **back** in time in relation to the main signal. Inserting a delay into the **main** signal path of an analogue dynamics processor will achieve similar results, but with the penalty of delaying the main signal by the amount of look ahead delay introduced.

The peak limiter follows the RMS limiter, has only two parameters to adjust – the release time and the threshold. Note that the threshold is set to be a minimum of 2dB above the threshold of the program limiter – setting the threshold to "10dB above" means that no more than 10dB of overshoot above the threshold of the program limiter will ever be allowed.

The release time can also be automatically set if the RMS limiter has automatic time constants enabled and so are set by the high pass filter frequency for that channel.



Setting Accurate Limiter Thresholds – Program Limiter

The limiters built into your amplifier are intended to be used for loudspeaker driver protection, as opposed to amplifier protection. The amplifier has additional limiters which can adapt automatically to both temperature and incoming mains conditions to stay operational and playing music for as long as possible. The following section describes how to set up the units' limiters to provide exceptional protection against driver overheating and cone over-exursion.

Most speaker systems are given a power rating in Watts RMS. This is the maximum continuous power that the system will handle and often appears very conservative. In reality, as music program is far from continuous in nature, the peak power of the system is much higher – up to ten times the continuous figure. Any limiter, which is to protect the driver from damage, must be able to fulfil the following tasks:

- Have an attack time which is calculated to allow transients through but keep the RMS level below the speaker manufacturers specification;
- Have a release time which is sufficiently long to avoid the limiter itself modulating the program;
- Be intelligent enough to adjust the envelope of the limiter according to the frequency content of the program material.

The APA RMS limiters are capable of performing all these tasks. The only parameter that the user must set manually is the threshold, and it is crucial that this is done correctly. Consider the table below.

dBLimit	Power 8Ω	Power 4Ω	Power 2.7Ω ⁶	Power 2Ω
44	1884	3768	5582	7536
43	1496	2993	4276	5986
42	1189	2377	3396	4755
41	944	1888	2698	3777
40	750	1500	2143	3000
39	596	1192	1702	2383
38	473	946	1352	1893
37	376	752	1074	1504
36	299	598	853	1194
35	237	474	678	949
34	188	377	538	754
33	150	299	428	599
32	119	238	340	475
31	94	189	270	378
30	75	150	214	300
29	60	120	178	240
28	47	94	139	188
27	38	76	113	152
26	30	60	89	120
25	24	48	71	96
24	19	38	56	76
23	15	30	44	60
22	12	24	36	48
21	10	20	30	40
20	7.50	15	22	30

First, check the RMS power rating of the speaker system, and its impedance. Look up this value in the table above, using the closest value **below** the rated power of the speaker system. Note the corresponding 'dB' value. Note that, for safety, always set the limiter threshold 1 or 2 dB below the maximum allowable worked out using the above method.

⁶ 2.7Ω is the ideal subwoofer load of 3 x 8Ω drivers in parallel for most efficient power delivery

Setting Accurate Limiter Thresholds – Peak Limiter

Assuming the RMS limiter has been set correctly and, just as importantly, attack and release times have been chosen as appropriate to the driver to be protected, the peak limiter is typically set to limit overshoot to 3dB above the RMS limiter threshold.

This would allow peaks of twice the RMS power level to reach the outputs. If the driver has a peak power capability of more than double the rated RSM power, then this value can be increased.

To calculate the setting for the peak limiter it's:

$$10 \times (\text{Log}^{10}(\text{Peak_Power} / \text{RMS Power}))$$

So for example, a 15" driver has a quoted RMS power handling of 800W, and a peak power handling of 1600W, the calculation is

$$\begin{aligned} (1600/800) &= 2 \\ \text{Then } \text{Log}^{10}(2) &= 0.3010 \\ \text{Then } 10 \times 0.3010 &= 3.010 \text{ or } 3\text{dB} \end{aligned}$$

Speaker manufacturers may quote AES power in place of RMS power and "Program" instead of "Peak". These terms, whilst not strictly interchangeable, are similar as a "pair" of measurements. AES tends to be a slightly more conservative rating given the definition of how it is measured.

If AES power is quoted, then it normally is paired with the "Program" rating and so the calculation of the threshold for the peak limiter is still valid.

Setting Appropriate Attack and Release Times

Having control over the attack and release times of the program limiters allows the user to balance the required subjective quality of the limiter against the driver protection requirements. It does also mean that an incorrectly set limiter may sound awful!

In particular (as with all limiters) using too fast an attack or release time will result in excessive low frequency distortion. When setting limiter attack and release times in the remote software there is an option for automatic limiter time constants. Use this option if you are unsure how to set the time constants manually.

XTA recommend the use of the automatic setting.

In this mode the time constants will be automatically set from the high pass crossover filter frequency according to the table below:

High Pass Filter	Auto Attack Time	Auto Release Time
<10Hz – 31Hz	45mS	x16 {720mS}
31Hz – 63Hz	16mS	x16 {256mS}
63Hz – 125Hz	8mS	x16 {128mS}
125Hz – 250Hz	4mS	x16 {64mS}
250Hz – 500Hz	2mS	x16 {32mS}
500Hz - 1kHz	1mS	x16 {16mS}
1kHz – 2kHz	0.5mS	x16 {8mS}
2kHz – 32kHz	0.3mS	x16 {4mS}



Appendix III: Parametric Filter Types and Uses

A wide selection of filter types has been made available under the PEQ section when editing input or output filters. Each filter type will be explained in turn in the following section.

Standard Parametric EQ

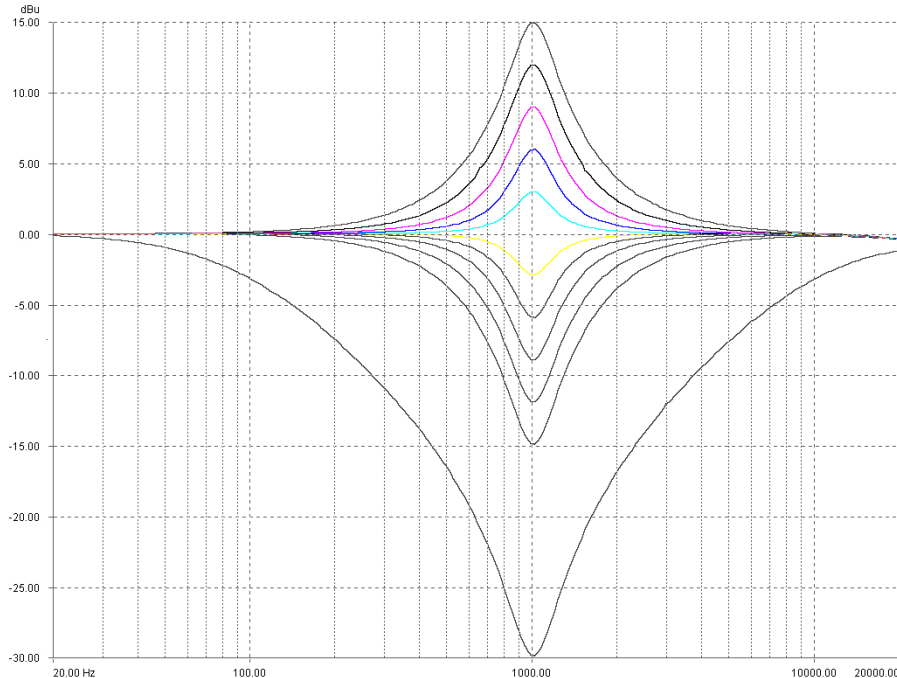

The standard parametric band has adjustable frequency, 'Q' (or Bandwidth) and Gain controls. These affect a range of frequencies symmetrically about the centre frequency as shown in the graph. Various levels of cut and boost are shown below, along with various 'Q' settings (gain boosts only are shown below). Remember that 'Q' is 1/Bandwidth, so the higher the 'Q', the lower the Bandwidth, and the smaller the range of frequencies affected.

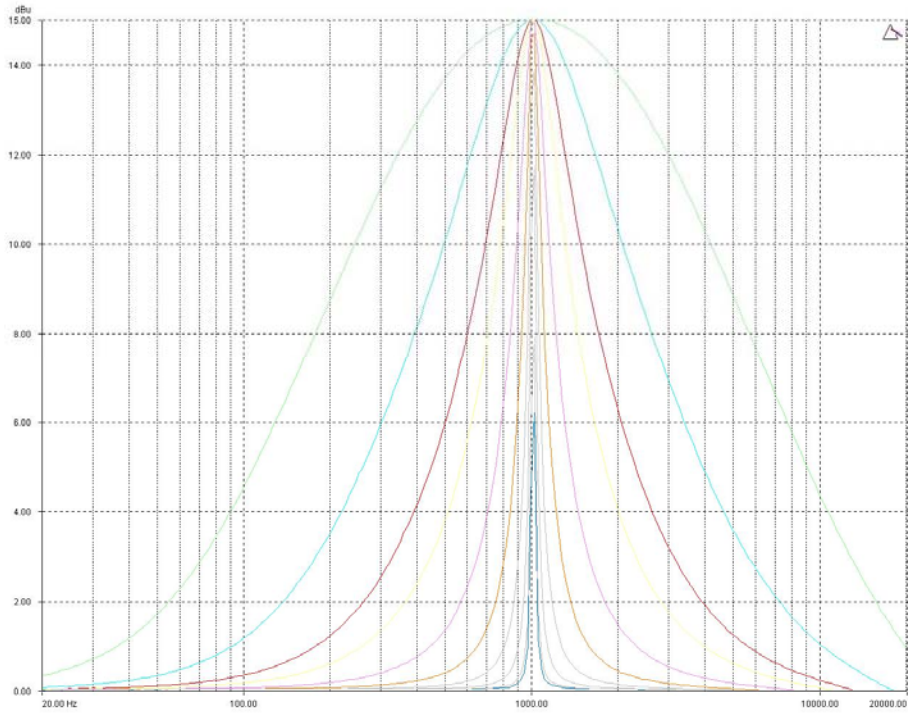

High/Low Shelving EQ (High Shelf shown)

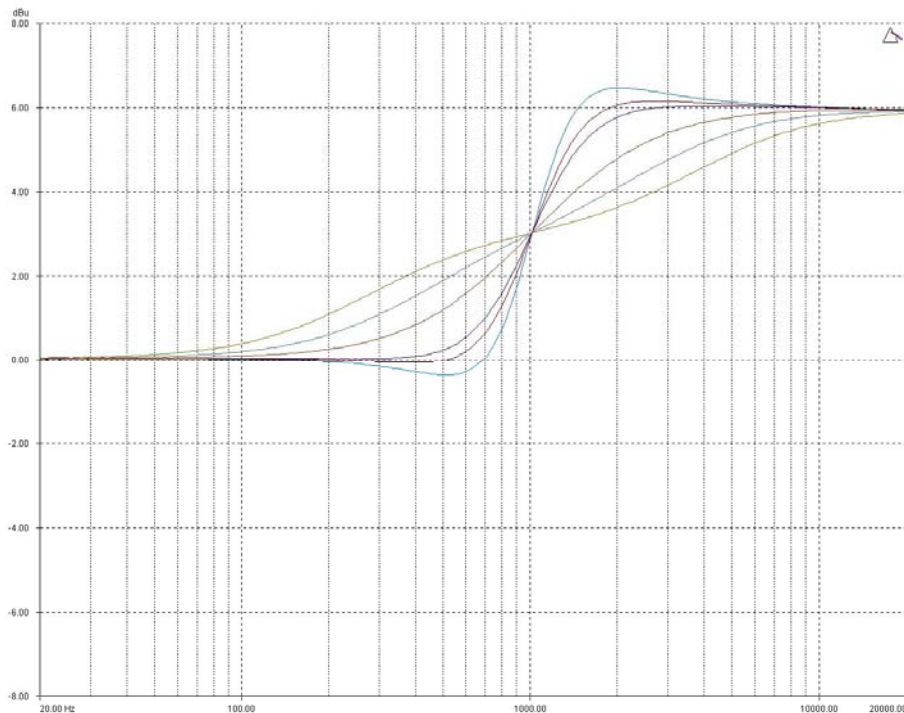

The shelving EQ has adjustable frequency, 'Q' (or Bandwidth) and Gain controls. These affect a range of frequencies from the turnover frequency as shown in the graph. For a high shelf, frequencies above the turnover frequency will be affected. For a low shelf, frequencies below the turnover frequency will be affected.

Various levels of cut and boost are shown below, along with various 'Q' settings (gain boosts only are shown below).

Remember that 'Q' is $1/\text{Bandwidth}$, so the higher the 'Q', the lower the Bandwidth, and the smaller the range of frequencies affected. Note that 'Q' settings above 0.75 will result in slight overshoot in the filter response (as seen at the highest setting to the right). This is normal behaviour and does not indicate instability.

Creating a Flat-topped EQ Response

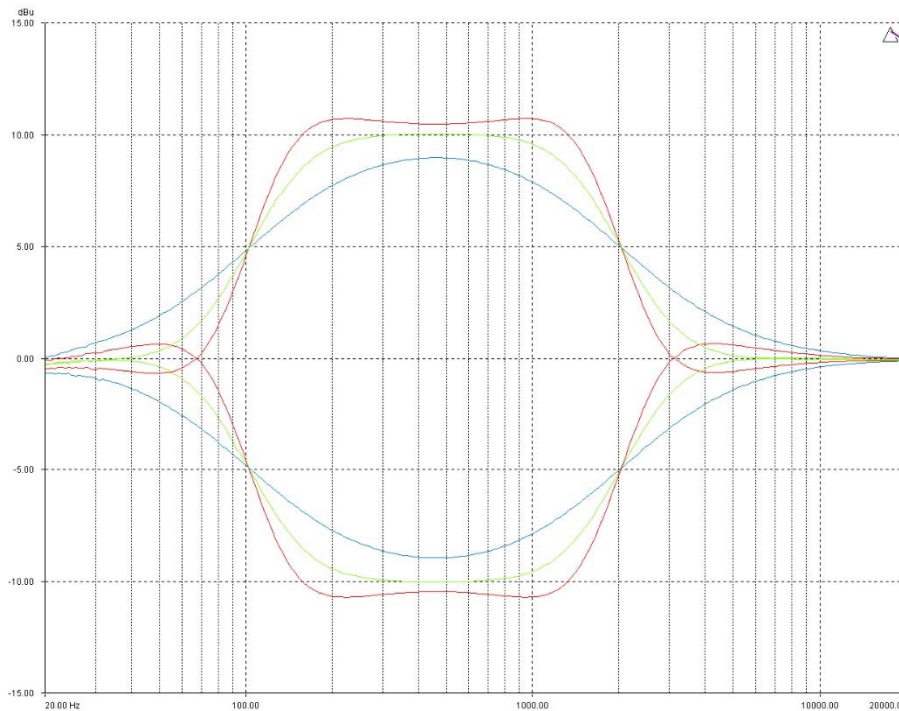

To create a flat-topped EQ filter response such as that shown to the left, use two EQ bands, BOTH configured as low shelves. For an overall BOOST, set the Lower frequency filter to BOOST the desired amount, and the Upper frequency filter to CUT by the same amount.

This example shows one filter at 100Hz and the other at 2kHz, with the 100Hz filter at -10dB, and the 2kHz filter at +10dB. Varying the 'Q' affects the slope of the response - values above 0.75 will cause overshoot as shown.

Assymetrical responses may be achieved by adjusting the 'Q' of each filter independantly.

Bandpass Filter

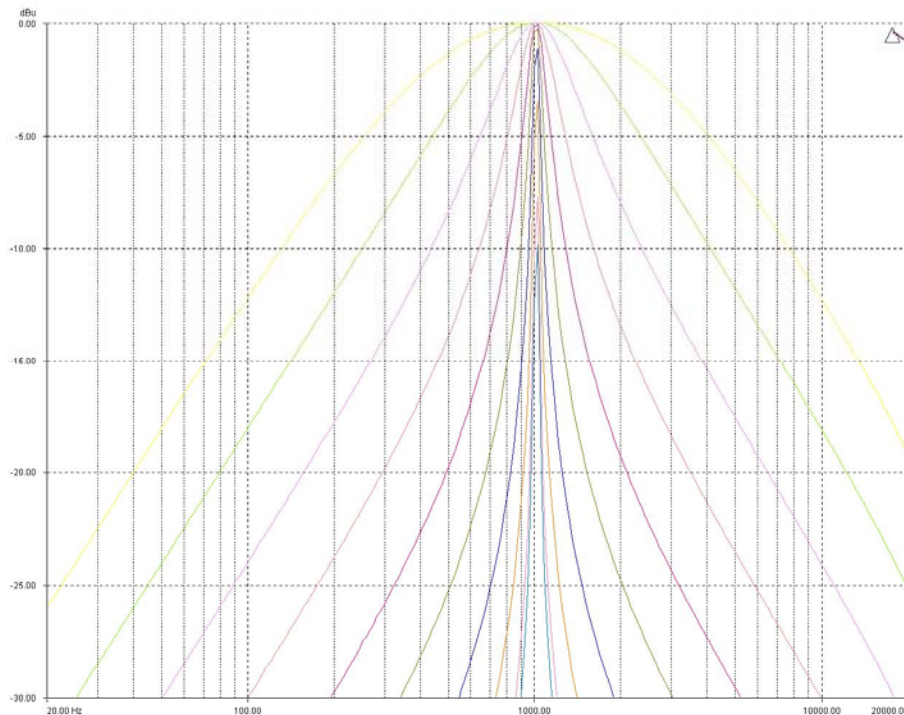

The bandpass filter has adjustable frequency and 'Q' (or Bandwidth) controls. These affect a range of frequencies symmetrically about the centre frequency as shown in the graph, gradually cutting the level, but providing no gain.

Remember that 'Q' is $1/\text{Bandwidth}$, so the higher the 'Q', the lower the Bandwidth, and the smaller the range of frequencies affected. Note that the response is fundamentally NOT a flat-topped response (so it is not constructed from a high pass and low pass). See previous page for details of how to construct a flat-topped filter response.

Notch Filter

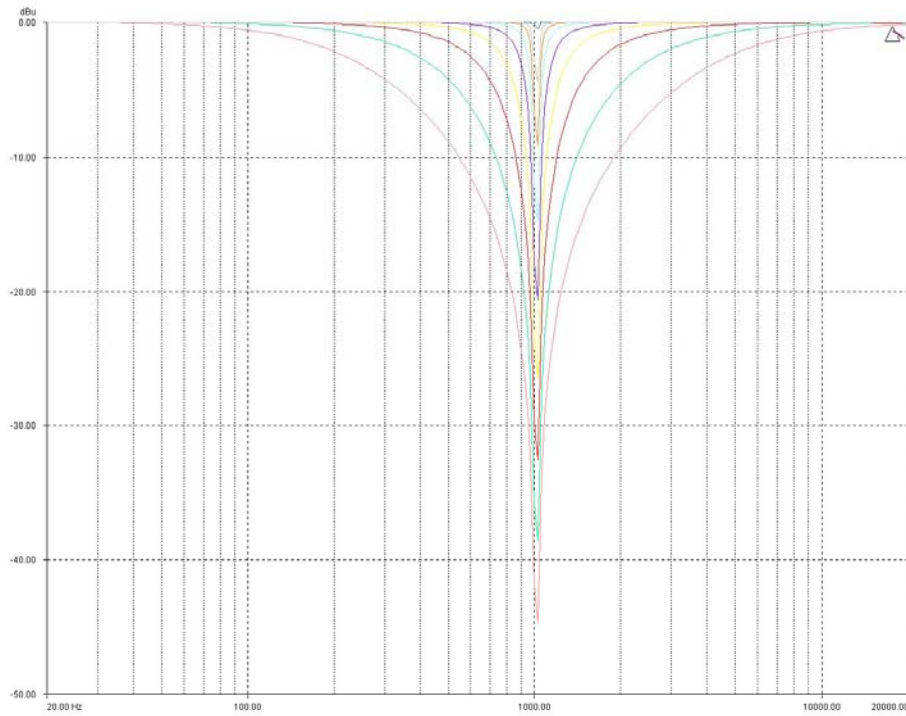

The notch filter has adjustable frequency and 'Q' (or Bandwidth) controls. These affect a range of frequencies symmetrically about the centre frequency as shown in the graph.

Remember that 'Q' is 1/Bandwidth, so the higher the 'Q', the lower the Bandwidth, and the smaller the range of frequencies affected. The notch filter depth varies with bandwidth – the wider the filter, the lower the depth will be.

All Pass Filter

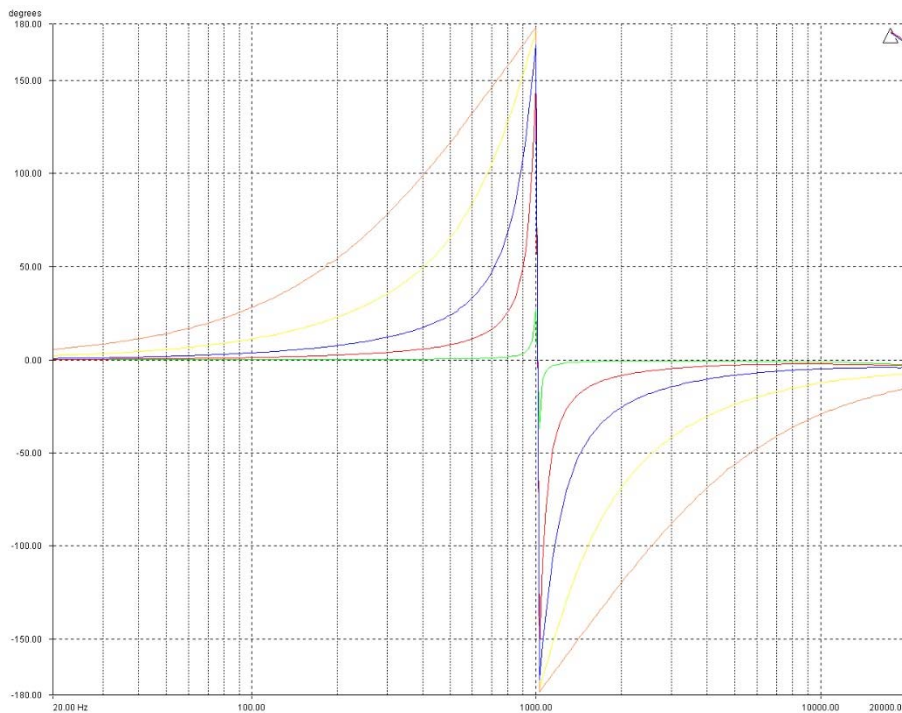

The allpass filter has adjustable frequency and 'Q' (or Bandwidth) controls. These affect the frequency at which the phase effectively flips 180°, and the 'speed' at which this transition occurs. The graph shows an allpass filter centred at 1kHz, with various 'Q' settings – the higher the 'Q' the faster the transition.

Phase Filter

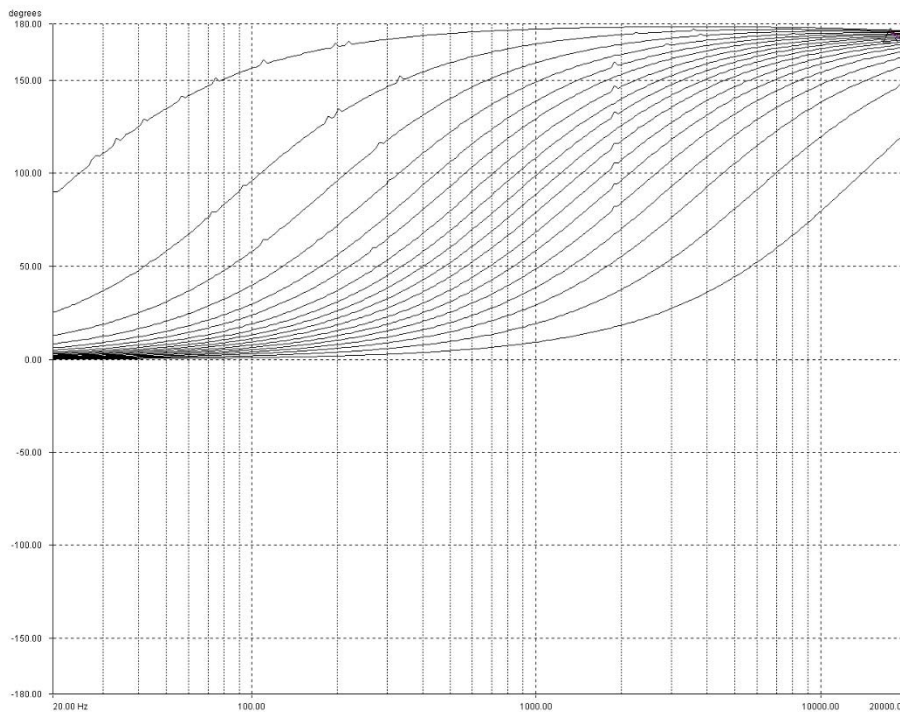

The phase filter has adjustable frequency, and phase shift controls. This introduces a phase shift that gradually changes from 180° above the centre frequency to the specified value at the centre frequency, and tending towards 0° below the centre frequency.

This graph shows the phase shift relative to the input (ignoring processing delays), in 10° steps – the filter will actually provide higher resolution than this, operating in 2° steps. The filter is centred at 1kHz in this example.



Low/High Pass Variable 'Q' Filter (Low Pass shown)

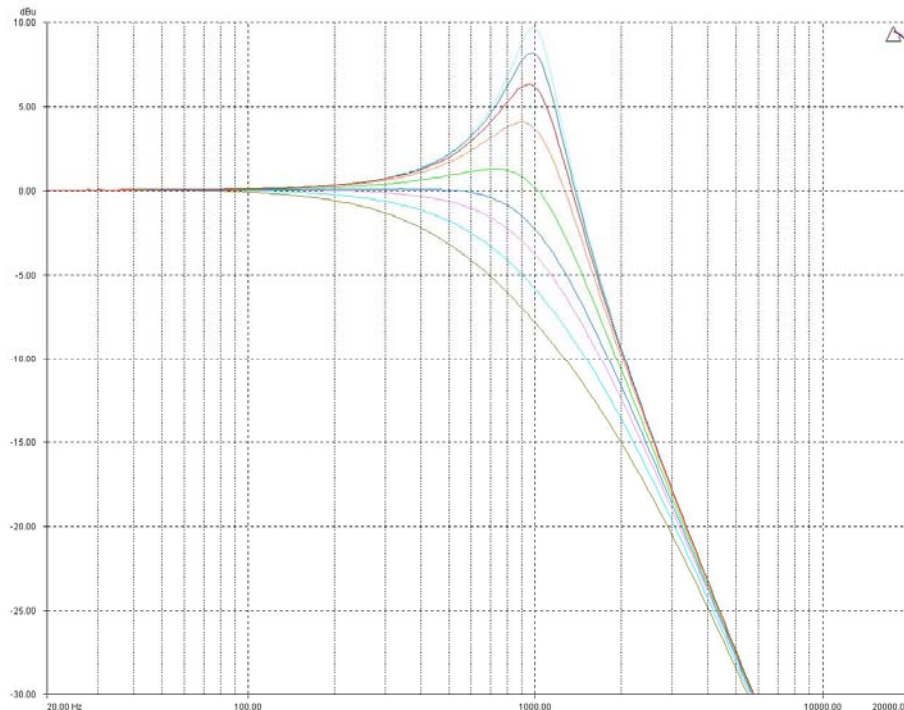

The low and high pass variable 'Q' filters have adjustable frequency and 'Q' (or Bandwidth) controls. The 'Q' control adjust the damping of the filter, so that low 'Q' settings show less overshoot at the turnover frequency, but also slower roll-off.

Remember that 'Q' is $1/\text{Bandwidth}$, so the higher the 'Q', the lower the Bandwidth, and the smaller the range of frequencies affected.

The filter is primarily 12dB/Octave, but in achieving this sort of roll-off with a high 'Q' value will result in quite a large overshoot in level at the turnover frequency. This type of filter is often also called a resonant filter.